

HSR

LM Guide Global Standard Size Model HSR

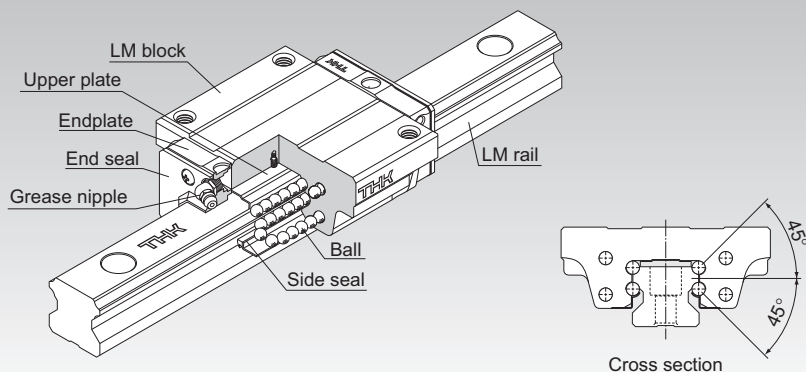

Point of Selection **A1-10**

Point of Design **A1-454**

Options **A1-477**

Model No. **A1-543**

Precautions on Use **A1-549**

Accessories for Lubrication **A24-1**

Mounting Procedure and Maintenance **B1-89**

Equivalent moment factor **A1-43**

Rated Loads in All Directions **A1-59**

Equivalent factor in each direction **A1-61**

Radial Clearance **A1-72**

Accuracy Standards **A1-77**

Shoulder Height of the Mounting Base and the Corner Radius **A1-465**

Permissible Error of the Mounting Surface **A1-470**

Dimensions of Each Model with an Option Attached **A1-491**

Structure and Features

Balls roll in four rows of raceways precision-ground on an LM rail and an LM block, and endplates incorporated in the LM block allow the balls to circulate.

Since retainer plates hold the balls, they do not fall off even if the LM rail is pulled out (except models HSR 8, 10 and 12).

Each row of balls is placed at a contact angle of 45° so that the rated loads applied to the LM block are uniform in the four directions (radial, reverse radial and lateral directions), enabling the LM Guide to be used in all orientations. In addition, the LM block can receive a well-balanced preload, increasing the rigidity in the four directions while maintaining a constant, low friction coefficient. With the low sectional height and the high rigidity design of the LM block, this model achieves highly accurate and stable straight motion.

[4-way Equal Load]

Each row of balls is placed at a contact angle of 45° so that the rated loads applied to the LM block are uniform in the four directions (radial, reverse radial and lateral directions), enabling the LM Guide to be used in all orientations and in extensive applications.

[High Rigidity Type]

Since balls are arranged in four rows in a well-balanced manner, a large preload can be applied and the rigidity in four directions can easily be increased.

[Self-adjustment Capability]

The self-adjustment capability through front-to-front configuration of THK's unique circular-arc grooves (DF set) enables a mounting error to be absorbed even under a preload, thus to achieve highly accurate, smooth straight motion.

[High Durability]

Even under a preload or excessive biased load, differential slip of balls does not occur. As a result, smooth motion, high wear resistance, and long-term maintenance of accuracy are achieved.

[Stainless Steel Type also Available]

A special type which LM block, LM rail and balls are made of stainless steel is also available.

Types

Models HSR-C/XC

The flange of the LM block has tapped holes. Can be mounted from the top or the bottom. Used in places where the table cannot have through holes for mounting bolts.

Specification Table⇒ [A1-186](#)

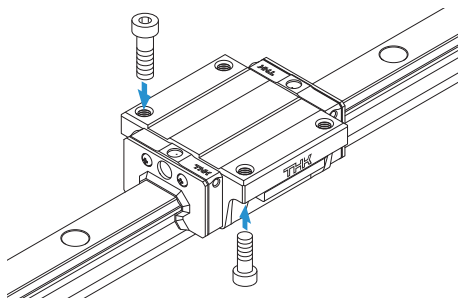

Models HSR-LC/XLC

The LM block has the same cross-sectional shape as model HSR-C, but has a longer overall LM block length (L) and a greater rated load.

Specification Table⇒ [A1-186](#)

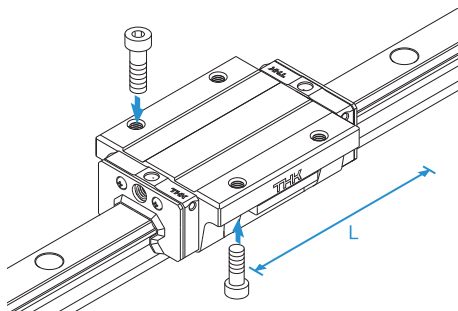

Models HSR-R/XR

With this type, the LM block has a smaller width (W) and tapped holes. Used in places where the space for table width is limited.

Specification Table⇒ [A1-188](#)/[A1-190](#)

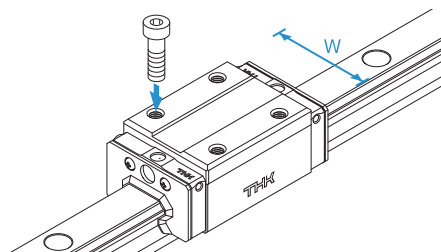

Models HSR-LR/XLR

The LM block has the same cross-sectional shape as model HSR-R, but has a longer overall LM block length (L) and a greater rated load.

Specification Table⇒ **A1-190**

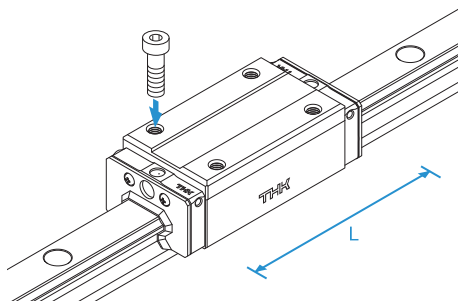

Model HSR-A

The flange of its LM block has tapped holes.

Specification Table⇒ **A1-192**

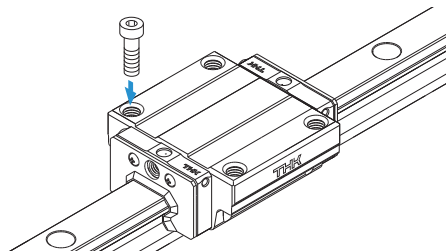

Model HSR-LA

The LM block has the same cross-sectional shape as model HSR-A, but has a longer overall LM block length (L) and a greater rated load.

Specification Table⇒ **A1-192**

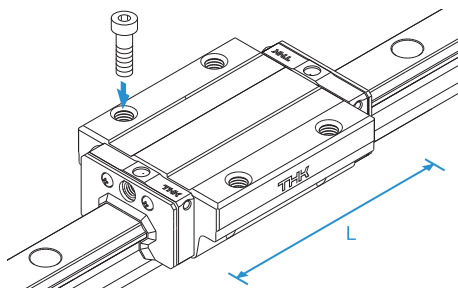

Model HSR-B

The flange of the LM block has through holes. Used in places where the table cannot have through holes for mounting bolts.

Specification Table⇒ **A1-194**

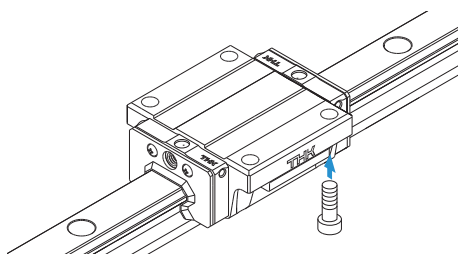

Model HSR-LB

Specification Table → [A1-194](#)

The LM block has the same cross-sectional shape as model HSR-B, but has a longer overall LM block length (L) and a greater rated load.

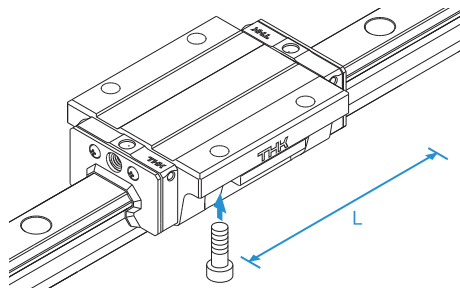

Models HSR-YR/XYR

Specification Table → [A1-196](#)

When using two conventional LM Guide units facing each other, it would take a long time to machine the table, and it was difficult to achieve the desired accuracy and adjust the clearance. With the Model HSR-YR and Model HSR-XYR, the tapped holes on the side of the LM block simplify the structure, which drastically reduces labor time and increases accuracy.

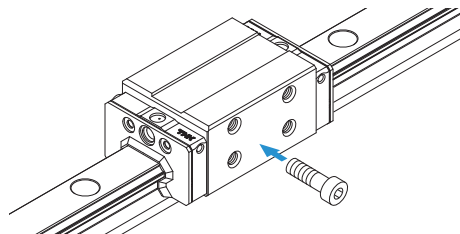

Fig.1 Conventional Structure

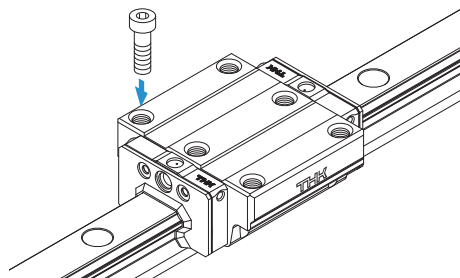

Fig.2 Mounting Structure for Model HSR-YR

Models HSR-CA/XCA

Specification Table → [A1-198](#)

Has six tapped holes on the LM block.



Models HSR-CB/XCB

The LM block has six through holes. Used in places where the table cannot have through holes for mounting bolts.

Specification Table⇒ **A1-200**

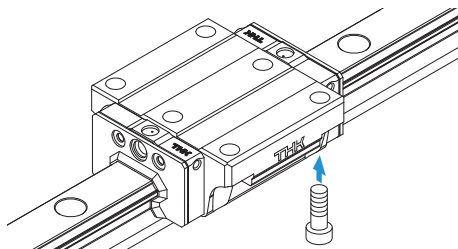

Models HSR-HA/XHA

The LM block has the same cross-sectional shape as model HSR-CA, but has a longer overall LM block length (L) and a greater rated load.

Specification Table⇒ **A1-198**

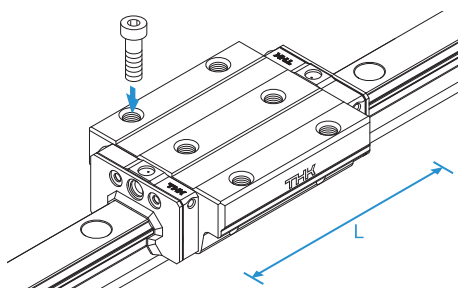

Models HSR-HB/XHB

The LM block has the same cross sectional shape as model HSR-CB, but has a longer overall LM block length (L) and a greater rated load.

Specification Table⇒ **A1-200**

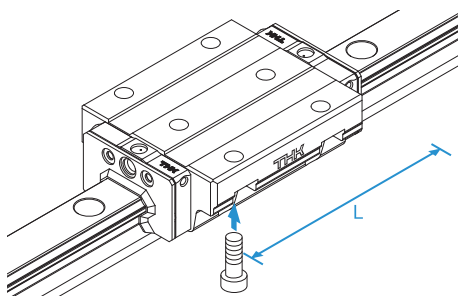

Models HSR 100/120/150 HA/HB/HR

Large types of model HSR that can be used in large-scale machine tools and building structures.

Specification Table⇒ **A1-202**

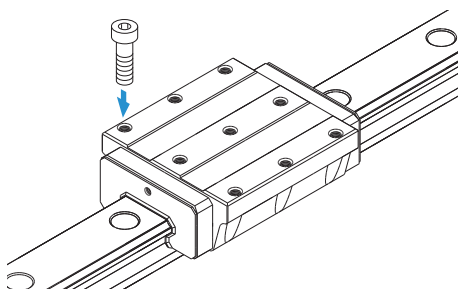

Models HSR-C, HSR-CM, HSR-LC, HSR-LCM, HSR-XC and HSR-XLC

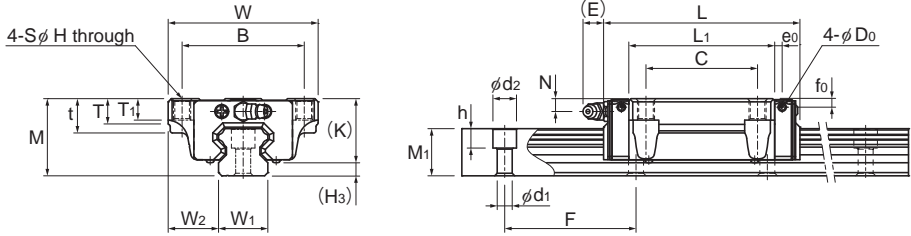

Models HSR15 to 35C/LC/CM/LCM

Model No.	Outer dimensions			LM block dimensions													Pilot hole for side nipple			
	Height	Width	Length	B	C	S	H	L ₁	t	T	T ₁	K	N	E	Grease nipple	e ₀	f ₀	D ₀	H ₃	
	M	W	L																	
HSR 15C HSR 15CM	24	47	56.6	38	30	M5	4.5	38.8	11	7	7	19.3	4.3	5.5	PB1021B	3.2	3.9	3	4.7	
HSR 15LC HSR 15LCM	24	47	74.6	38	30	M5	4.5	56.8	11	7	7	19.3	4.3	5.5	PB1021B	3.2	3.9	3	4.7	
HSR 20C HSR 20CM	30	63	74	53	40	M6	5.4	50.8	10	9.5	10	26	5	12	B-M6F	3.1	3.4	3	4	
HSR 20LC HSR 20LCM	30	63	90	53	40	M6	5.4	66.8	10	9.5	10	26	5	12	B-M6F	3.1	3.4	3	4	
HSR 25C HSR 25CM	36	70	83.1	57	45	M8	6.8	59.5	16	11	10	30.5	6	12	B-M6F	3.5	4	3	5.5	
HSR 25LC HSR 25LCM	36	70	102.2	57	45	M8	6.8	78.6	16	11	10	30.5	6	12	B-M6F	3.5	4	3	5.5	
HSR 30C HSR 30CM	42	90	98	72	52	M10	8.5	70.4	18	9	10	35	7	12	B-M6F	5.2	6.2	5.2	7	
HSR 30LC HSR 30LCM	42	90	120.6	72	52	M10	8.5	93	18	9	10	35	7	12	B-M6F	5.2	6.2	5.2	7	
HSR 35C HSR 35CM	48	100	109.4	82	62	M10	8.5	80.4	21	12	13	40.5	8	12	B-M6F	5.5	5.6	5.2	7.5	
HSR 35LC HSR 35LCM	48	100	134.8	82	62	M10	8.5	105.8	21	12	13	40.5	8	12	B-M6F	5.5	5.6	5.2	7.5	
HSR 45C HSR 45LC	60	120	139 170.8	100	80	M12	10.5	98 129.8	25	13	15	50	10	16	B-PT1/8	6.1	6.6	5.2	10	
HSR 55C HSR 55LC	70	140	163 201.1	116	95	M14	12.5	118 156.1	29	13.5	17	57	11	16	B-PT1/8	5.6	7.7	5.2	13	
HSR 65XC HSR 65XLC	90	170	190.5 250	142	110	M16	14.5	138.5 198	37	21.5	23	76	19	16	B-PT1/8	6.8	14.6	5.2	14	

Model number coding

HSR25 C 2 QZ UU C0 M +1200L P T M - II

Model number

Type of LM block

With QZ Lubricator

Contamination protection accessory symbol (*1)

Stainless steel LM block

LM rail length (in mm)

Stainless steel LM rail
Symbol for LM rail jointed use

Symbol for No. of rails used on the same plane (*4)

No. of LM blocks used on the same rail

Radial clearance symbol (*2)
Normal (No symbol)
Light preload (C1)
Medium preload (C0)

Accuracy symbol (*3)
Normal grade (No Symbol)/High accuracy grade (H)
Precision grade (P)/Super precision grade (SP)
Ultra precision grade (UP)

(*1) See contamination protection accessory on **A1-516**. (*2) See **A1-72**. (*3) See **A1-77**. (*4) See **A1-13**.

Note) This model number indicates that a single-rail unit constitutes one set. (i.e., required number of sets when 2 rails are used in parallel is 2 at a minimum.) Those models equipped with QZ Lubricator cannot have a grease nipple. When desiring a grease nipple for a model attached with QZ, contact THK.

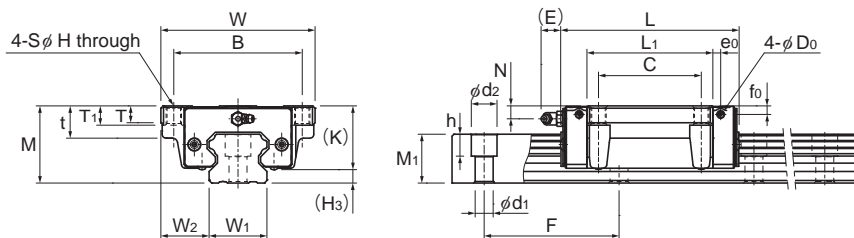

Models HSR45 to 65C/LC/XC/LC

Unit: mm

LM rail dimensions						Basic load rating		Static permissible moment $\text{kN}\cdot\text{m}^*$					Mass	
Width W_1 ± 0.05	Height M_1	Pitch F	Length* Max	$d_1 \times d_2 \times h$	C	C_0	M_A		M_B		M_C	LM block kg	LM rail kg/m	
							1 block	Double blocks	1 block	Double blocks	1 block			
15	16	15	60	$4.5 \times 7.5 \times 5.3$	3000 (1240)	10.9	15.7	0.0945	0.527	0.0945	0.527	0.0998	0.2	1.5
15	16	15	60	$4.5 \times 7.5 \times 5.3$	3000 (1240)	14.2	22.9	0.194	0.984	0.194	0.984	0.145	0.29	1.5
20	21.5	18	60	$6 \times 9.5 \times 8.5$	3000 (1480)	19.8	27.4	0.218	1.2	0.218	1.2	0.235	0.35	2.3
20	21.5	18	60	$6 \times 9.5 \times 8.5$	3000 (1480)	23.9	35.8	0.363	1.87	0.363	1.87	0.307	0.47	2.3
23	23.5	22	60	$7 \times 11 \times 9$	3000 (2020)	27.6	36.4	0.324	1.8	0.324	1.8	0.366	0.59	3.3
23	23.5	22	60	$7 \times 11 \times 9$	3000 (2020)	35.2	51.6	0.627	3.04	0.627	3.04	0.518	0.75	3.3
28	31	26	80	$9 \times 14 \times 12$	3000 (2520)	40.5	53.7	0.599	3.1	0.599	3.1	0.652	1.1	4.8
28	31	26	80	$9 \times 14 \times 12$	3000 (2520)	48.9	70.2	0.995	4.89	0.995	4.89	0.852	1.3	4.8
34	33	29	80	$9 \times 14 \times 12$	3000 (2520)	53.9	70.2	0.895	4.51	0.895	4.51	1.05	1.6	6.6
34	33	29	80	$9 \times 14 \times 12$	3000 (2520)	65	91.7	1.49	7.13	1.49	7.13	1.37	2.0	6.6
45	37.5	38	105	$14 \times 20 \times 17$	3090	82.2 100	101 135	1.5 2.59	8.37 13.4	1.5 2.59	8.37 13.4	1.94 2.6	2.8 3.3	11 11
53	43.5	44	120	$16 \times 23 \times 20$	3060	121 148	146 194	2.6 4.46	14.1 22.7	2.6 4.46	14.1 22.7	3.43 4.56	4.5 5.7	15.1 15.1
63	53.5	53	150	$18 \times 26 \times 22$	3000	195 249	228 323	5.08 9.81	25 45.6	5.08 9.81	25 45.6	6.2 8.79	8.5 10.7	22.5 22.5

Note) The maximum length under "Length*" indicates the standard maximum length of an LM rail. (See **A1-204**.)

Static permissible moment* 1 block: the static permissible moment with one LM block

Double blocks: static permissible moment when two LM blocks are in close contact with each other
The overall block lengths (L) in the dimension table are for when the contamination protection accessory symbol is UU or SS.
The overall block length (L) will increase if another contamination protection accessory or lubricator is attached.

(See **A1-491** or **A1-512**)

An "M" in the model number indicates the material of the LM block, LM rail, or balls are stainless steel.

Stainless steel products have superior corrosion resistance and environmental resistance.

*The diagram shows the side nipple pilot holes for when a grease nipple is desired for a product with LaCS or a QZ Lubricator.

In all other cases, the side nipple pilot holes will not be through holes.

Consult with THK if you desire drilling for grease nipple mounting. (See **A1-430**.)

Model HSR-RM

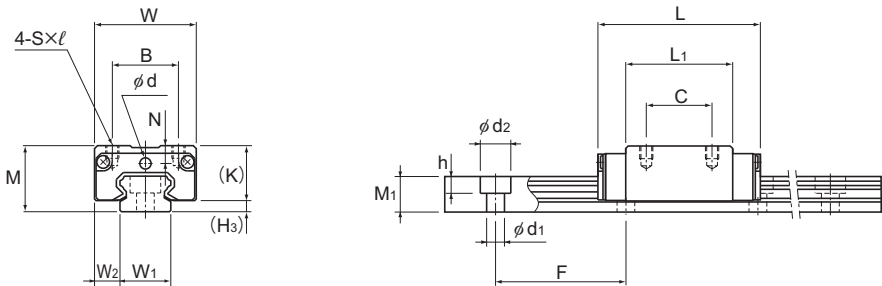

Models HSR8RM and 10RM

Model No.	Outer dimensions			LM block dimensions										H ₃
	Height	Width	Length	B	C	S×ℓ	L ₁	T	K	N	E	Greasing hole d	Grease nipple	
	M	W	L											
HSR 8RM	11	16	24	10	10	M2×2.5	15	—	8.9	2.6	—	2.2	—	2.1
HSR 10RM	13	20	31	13	12	M2.6×2.5	20.1	—	10.8	3.5	—	2.5	—	2.2
HSR 12RM	20	27	45	15	15	M4×4.5	30.5	6	16.9	5.2	4	—	PB107	3.1

Model number coding

HSR12 R 2 UU C1 M +670L H T M -II

Model number

Type of LM block

Contamination protection accessory symbol (*1)

Stainless steel LM block

LM rail length (in mm)

Stainless steel LM rail

Symbol for No. of rails used on the same plane (*4)

No. of LM blocks used on the same rail

Radial clearance symbol (*2)
Normal (No symbol)
Light preload (C1)

Symbol for LM rail jointed use

Accuracy symbol (*3)
Normal grade (No Symbol)/High accuracy grade (H)
Precision grade (P)/Super precision grade (SP)

(*1) See contamination protection accessory on **A1-516**. (*2) See **A1-72**. (*3) See **A1-77**. (*4) See **A1-13**.

Note) This model number indicates that a single-rail unit constitutes one set. (i.e., required number of sets when 2 rails are used in parallel is 2 at a minimum.)

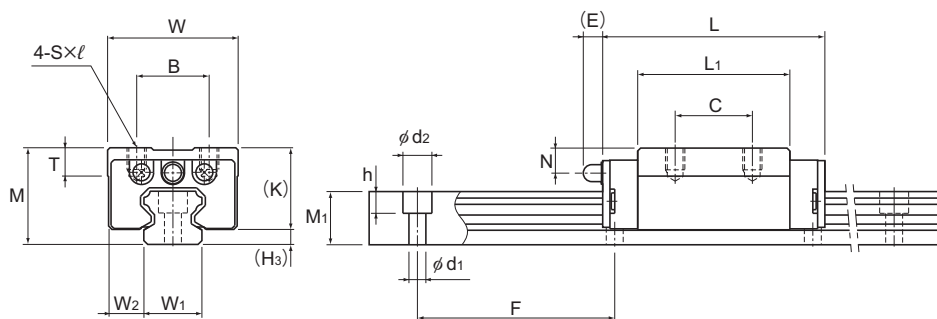

Model HSR12RM

Unit: mm

LM rail dimensions						Basic load rating		Static permissible moment $kN \cdot m^*$					Mass	
Width	Height	Pitch		Length*	C	C ₀	M _A		M _B		M _C	LM block	LM rail	
W_1 ± 0.05	W_2	M_1	F	$d_1 \times d_2 \times h$	Max	kN	kN	1 block	Double blocks	1 block	Double blocks	1 block	kg	kg/m
8	4	6	20	$2.4 \times 4.2 \times 2.3$	(975)	1.08	2.16	0.00492	0.0319	0.00492	0.0319	0.00727	0.012	0.3
10	5	7	25	$3.5 \times 6 \times 3.3$	(995)	1.96	3.82	0.0123	0.0716	0.0123	0.0716	0.0162	0.025	0.45
12	7.5	11	40	$3.5 \times 6 \times 4.5$	(1240)	4.7	8.53	0.0409	0.228	0.0409	0.228	0.0445	0.08	0.83

Note) The maximum length under "Length*" indicates the standard maximum length of an LM rail. (See **A1-204**.)

Static permissible moment* 1 block: the static permissible moment with one LM block

Double blocks: static permissible moment when two LM blocks are in close contact with each other
 Overall block length dimension (L) The overall block lengths (L) in the dimension table are for when the contamination protection accessory symbol is UU or SS.
 The overall block length (L) will increase if another contamination protection accessory or lubricator is attached.

(See **A1-491** or **A1-512**)

An "M" in the model number indicates the material of the LM block, LM rail, or balls are stainless steel.
 Stainless steel products have superior corrosion resistance and environmental resistance.

Models HSR-R, HSR-RM, HSR-LR, HSR-LRM, HSR-XR and HSR-XLR

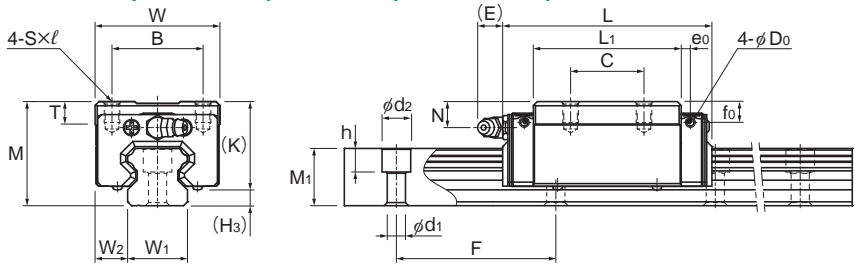

Models HSR15 to 35R/LR/RM/LRM

Model No.	Outer dimensions			LM block dimensions										Pilot hole for side nipple			H ₃
	Height	Width	Length	B	C	S × l	L ₁	T	K	N	E	Grease nipple	e ₀	f ₀	D ₀		
	M	W	L														
HSR 15R HSR 15RM	28	34	56.6	26	26	M4 × 5	38.8	6	23.3	8.3	5.5	PB1021B	3.2	7.9	3	4.7	
HSR 15LR HSR 15LRM	28	34	74.6	26	34	M4 × 5	56.8	6	23.3	8.3	5.5	PB1021B	3.2	7.9	3	4.7	
HSR 20R HSR 20RM	30	44	74	32	36	M5 × 6	50.8	8	26	5	12	B-M6F	3.1	3.4	3	4	
HSR 20LR HSR 20LRM	30	44	90	32	50	M5 × 6	66.8	8	26	5	12	B-M6F	3.1	3.4	3	4	
HSR 25R HSR 25RM	40	48	83.1	35	35	M6 × 8	59.5	9	34.5	10	12	B-M6F	3.5	8	3	5.5	
HSR 25LR HSR 25LRM	40	48	102.2	35	50	M6 × 8	78.6	9	34.5	10	12	B-M6F	3.5	8	3	5.5	
HSR 30R HSR 30RM	45	60	98	40	40	M8 × 10	70.4	9	38	10	12	B-M6F	5.2	9.2	5.2	7	
HSR 30LR HSR 30LRM	45	60	120.6	40	60	M8 × 10	93	9	38	10	12	B-M6F	5.2	9.2	5.2	7	
HSR 35R HSR 35RM	55	70	109.4	50	50	M8 × 12	80.4	11.7	47.5	15	12	B-M6F	5.5	12.6	5.2	7.5	
HSR 35LR HSR 35LRM	55	70	134.8	50	72	M8 × 12	105.8	11.7	47.5	15	12	B-M6F	5.5	12.6	5.2	7.5	
HSR 45R HSR 45LR	70	86	139 170.8	60	60 80	M10 × 17	98 129.8	15	60	20	16	B-PT1/8	6.1	16.6	5.2	10	
HSR 55R HSR 55LR	80	100	163 201.1	75	75 95	M12 × 18	118 156.1	20.5	67	21	16	B-PT1/8	5.6	17.7	5.2	13	
HSR 65XR HSR 65XLR	90	126	190.5 250	76	70 120	M16 × 20	138.5 198	23	76	19	16	B-PT1/8	6.8	14.6	5.2	14	
HSR 65R HSR 65LR	90	126	186 245.5	76	70 120	M16 × 20	147 206.5	23	76	19	16	B-PT1/8	—	—	—	14	
HSR 85R HSR 85LR	110	156	245.6 303	100	80 140	M18 × 25	178.6 236	29	94	23	16	B-PT1/8	—	—	—	16	

Model number coding

HSR35 R 2 QZ SS C0 M +1400L P T M - II

Model number	Type of LM block	With QZ Lubricator	Contamination protection accessory symbol (*1)	Stainless steel LM block	LM rail length (in mm)	Stainless steel LM rail	Symbol for LM rail jointed use	Symbol for No. of rails used on the same plane (*4)
	No. of LM blocks used on the same rail		Radial clearance symbol (*2) Normal (No symbol) Light preload (C1) Medium preload (C0)					

(*1) See contamination protection accessory on **A1-516**. (*2) See **A1-72**. (*3) See **A1-77**. (*4) See **A1-13**.

(Note) This model number indicates that a single-rail unit constitutes one set. (i.e., required number of sets when 2 rails are used in parallel is 2 at a minimum.) Those models equipped with QZ Lubricator cannot have a grease nipple. When desiring a grease nipple for a model attached with QZ, contact THK.

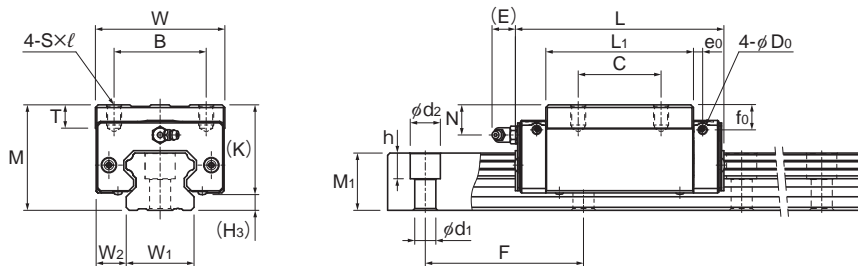

Models HSR45 to 85R/LR/XR/XLR

Unit: mm

LM rail dimensions						Basic load rating		Static permissible moment kN·m*					Mass	
Width W ₁ ±0.05	W ₂	Height M ₁	Pitch F	Pitch d ₁ × d ₂ × h	Length* Max	C kN	C ₀ kN	M _a		M _b		M _c	LM block kg	LM rail kg/m
								1 block	Double blocks	1 block	Double blocks	1 block		
15	9.5	15	60	4.5 × 7.5 × 5.3	3000 (1240)	10.9	15.7	0.0945	0.527	0.0945	0.527	0.0998	0.18	1.5
15	9.5	15	60	4.5 × 7.5 × 5.3	3000 (1240)	14.2	22.9	0.194	0.984	0.194	0.984	0.145	0.26	1.5
20	12	18	60	6 × 9.5 × 8.5	3000 (1480)	19.8	27.4	0.218	1.2	0.218	1.2	0.235	0.25	2.3
20	12	18	60	6 × 9.5 × 8.5	3000 (1480)	23.9	35.8	0.363	1.87	0.363	1.87	0.307	0.35	2.3
23	12.5	22	60	7 × 11 × 9	3000 (2020)	27.6	36.4	0.324	1.8	0.324	1.8	0.366	0.54	3.3
23	12.5	22	60	7 × 11 × 9	3000 (2020)	35.2	51.6	0.627	3.04	0.627	3.04	0.518	0.67	3.3
28	16	26	80	9 × 14 × 12	3000 (2520)	40.5	53.7	0.599	3.1	0.599	3.1	0.652	0.9	4.8
28	16	26	80	9 × 14 × 12	3000 (2520)	48.9	70.2	0.995	4.89	0.995	4.89	0.852	1.1	4.8
34	18	29	80	9 × 14 × 12	3000 (2520)	53.9	70.2	0.895	4.51	0.895	4.51	1.05	1.5	6.6
34	18	29	80	9 × 14 × 12	3000 (2520)	65	91.7	1.49	7.13	1.49	7.13	1.37	2	6.6
45	20.5	38	105	14 × 20 × 17	3090	82.2 100	101 135	1.5 2.59	8.37 13.4	1.5 2.59	8.37 13.4	1.94 2.6	2.6 3.1	11
53	23.5	44	120	16 × 23 × 20	3060	121 148	146 194	2.6 4.46	14.1 22.7	2.6 4.46	14.1 22.7	3.43 4.56	4.3 5.4	15.1
63	31.5	53	150	18 × 26 × 22	3000	195 249	228 323	5.08 9.81	25 45.6	5.08 9.81	25 45.6	6.2 8.79	7.3 9.7	22.5
63	31.5	53	150	18 × 26 × 22	3000	195 249	228 323	5.08 9.81	25 45.6	5.08 9.81	25 45.6	6.2 8.79	7.3 9.3	22.5
85	35.5	65	180	24 × 35 × 28	3000	304 367	355 464	10.2 16.9	51.2 81	10.2 16.9	51.2 81	12.8 16.7	13 16	35.2

Note) The maximum length under "Length*" indicates the standard maximum length of an LM rail. (See **A1-204**.)

Static permissible moment* 1 block: the static permissible moment with one LM block

Double blocks: static permissible moment when two LM blocks are in close contact with each other

Overall block length dimension (L)

The overall block lengths (L) in the dimension table are for when the contamination protection accessory symbol is UU or SS.

The overall block length (L) will increase if another contamination protection accessory or lubricator is attached.

(See **A1-491** or **A1-512**.)

An "M" in the model number indicates the material of the LM block, LM rail, or balls are stainless steel.

Stainless steel products have superior corrosion resistance and environmental resistance.

*The diagram shows the side nipple pilot holes for when a grease nipple is desired for a product with LaCS or a QZ Lubricator.

In all other cases, the side nipple pilot holes will not be through holes.

Consult with THK if you desire drilling for grease nipple mounting.

Models HSR-A and HSR-AM, Models HSR-LA and HSR-LAM

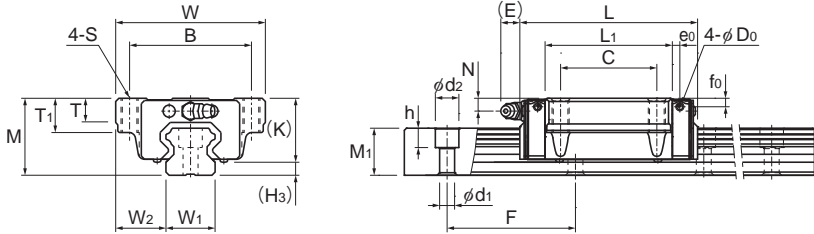

Models HSR15 to 35A/LA/AM/LAM

Model No.	Outer dimensions			LM block dimensions													Pilot hole for side nipple			
	Height	Width	Length	B	C	S	L ₁	t	T	T ₁	K	N	E	Grease nipple	e ₀	f ₀	D ₀	H ₃		
	M	W	L																	
HSR 15A HSR 15AM	24	47	56.6	38	30	M5	38.8	—	7	11	19.3	4.3	5.5	PB1021B	3.2	3.9	3	4.7		
HSR 20A HSR 20AM	30	63	74	53	40	M6	50.8	—	9.5	10	26	5	12	B-M6F	3.1	3.4	3	4		
HSR 20LA HSR 20LAM	30	63	90	53	40	M6	66.8	—	9.5	10	26	5	12	B-M6F	3.1	3.4	3	4		
HSR 25A HSR 25AM	36	70	83.1	57	45	M8	59.5	—	11	16	30.5	6	12	B-M6F	3.5	4	3	5.5		
HSR 25LA HSR 25LAM	36	70	102.2	57	45	M8	78.6	—	11	16	30.5	6	12	B-M6F	3.5	4	3	5.5		
HSR 30A HSR 30AM	42	90	98	72	52	M10	70.4	—	9	18	35	7	12	B-M6F	5.2	6.2	5.2	7		
HSR 30LA HSR 30LAM	42	90	120.6	72	52	M10	93	—	9	18	35	7	12	B-M6F	5.2	6.2	5.2	7		
HSR 35A HSR 35AM	48	100	109.4	82	62	M10	80.4	—	12	21	40.5	8	12	B-M6F	5.5	5.6	5.2	7.5		
HSR 35LA HSR 35LAM	48	100	134.8	82	62	M10	105.8	—	12	21	40.5	8	12	B-M6F	5.5	5.6	5.2	7.5		
HSR 45A HSR 45LA	60	120	139 170.8	100	80	M12	98 129.8	25	13	15	50	10	16	B-PT1/8	6.1	6.6	5.2	10		
HSR 55A HSR 55LA	70	140	163 201.1	116	95	M14	118 156.1	29	13.5	17	57	11	16	B-PT1/8	5.6	7.7	5.2	13		
HSR 65A HSR 65LA	90	170	186 245.5	142	110	M16	147 206.5	37	21.5	23	76	19	16	B-PT1/8	—	—	—	14		
HSR 85A HSR 85LA	110	215	245.6 303	185	140	M20	178.6 236	55	28	30	94	23	16	B-PT1/8	—	—	—	16		

Model number coding

HSR25 A 2 QZ UU C0 M +1200L P T M - II

Model number

Type of LM block

With QZ Lubricator

Contamination protection accessory symbol (*1)

Stainless steel LM block

LM rail length (in mm)

Stainless steel LM rail
Symbol for LM rail jointed use

Symbol for No. of rails used on the same plane (*4)

No. of LM blocks used on the same rail

Radial clearance symbol (*2)
Normal (No symbol)
Light preload (C1)
Medium preload (C0)

Accuracy symbol (*3)
Normal grade (No Symbol)/High accuracy grade (H)
Precision grade (P)/Super precision grade (SP)
Ultra precision grade (UP)

(*1) See contamination protection accessory on **A1-516**. (*2) See **A1-72**. (*3) See **A1-77**. (*4) See **A1-13**.

Note) This model number indicates that a single-rail unit constitutes one set. (i.e., required number of sets when 2 rails are used in parallel is 2 at a minimum.) Those models equipped with QZ Lubricator cannot have a grease nipple. When desiring a grease nipple for a model attached with QZ, contact THK.

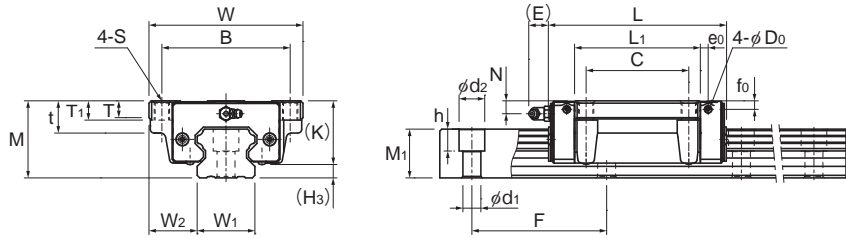

Models HSR45 to 85A/LA

Unit: mm

LM rail dimensions						Basic load rating		Static permissible moment kN·m*					Mass	
Width W_1 ±0.05	W_2	Height M_1	Pitch F	Length* $d_1 \times d_2 \times h$ Max	C kN	C_0 kN	M_A		M_B		M_C	LM block kg	LM rail kg/m	
							1 block	Double blocks	1 block	Double blocks	1 block			
15	16	15	60	4.5×7.5×5.3	3000 (1240)	10.9	15.7	0.0945	0.527	0.0945	0.527	0.0998	0.2	1.5
20	21.5	18	60	6×9.5×8.5	3000 (1480)	19.8	27.4	0.218	1.2	0.218	1.2	0.235	0.35	2.3
20	21.5	18	60	6×9.5×8.5	3000 (1480)	23.9	35.8	0.363	1.87	0.363	1.87	0.307	0.47	2.3
23	23.5	22	60	7×11×9	3000 (2020)	27.6	36.4	0.324	1.8	0.324	1.8	0.366	0.59	3.3
23	23.5	22	60	7×11×9	3000 (2020)	35.2	51.6	0.627	3.04	0.627	3.04	0.518	0.75	3.3
28	31	26	80	9×14×12	3000 (2520)	40.5	53.7	0.599	3.1	0.599	3.1	0.652	1.1	4.8
28	31	26	80	9×14×12	3000 (2520)	48.9	70.2	0.995	4.89	0.995	4.89	0.852	1.3	4.8
34	33	29	80	9×14×12	3000 (2520)	53.9	70.2	0.895	4.51	0.895	4.51	1.05	1.6	6.6
34	33	29	80	9×14×12	3000 (2520)	65	91.7	1.49	7.13	1.49	7.13	1.37	2	6.6
45	37.5	38	105	14×20×17	3090	82.2 100	101 135	1.5 2.59	8.37 13.4	1.5 2.59	8.37 13.4	1.94 2.6	2.8 3.3	11
53	43.5	44	120	16×23×20	3060	121 148	146 194	2.6 4.46	14.1 22.7	2.6 4.46	14.1 22.7	3.43 4.56	4.5 5.7	15.1
63	53.5	53	150	18×26×22	3000	195 249	228 323	5.08 9.81	25 45.6	5.08 9.81	25 45.6	6.2 8.79	8.5 10.7	22.5
85	65	65	180	24×35×28	3000	304 367	355 464	10.2 16.9	51.2 81	10.2 16.9	51.2 81	12.8 16.7	17 23	35.2

Note) The maximum length under "Length*" indicates the standard maximum length of an LM rail. (See [A1-204](#).)

Static permissible moment* 1 block: the static permissible moment with one LM block

Double blocks: static permissible moment when two LM blocks are in close contact with each other

Overall block length dimension (L)

The overall block lengths (L) in the dimension table are for when the contamination protection accessory symbol is UU or SS. The overall block length (L) will increase if another contamination protection accessory or lubricator is attached.

(See [A1-491](#) or [A1-512](#).)

An "M" in the model number indicates the material of the LM block, LM rail, or balls are stainless steel.

Stainless steel products have superior corrosion resistance and environmental resistance.

*The diagram shows the side nipple pilot holes for when a grease nipple is desired for a product with LaCS or a QZ Lubricator.

In all other cases, the side nipple pilot holes will not be through holes.

Consult with THK if you desire drilling for grease nipple mounting.

Models HSR-B, HSR-BM, HSR-LB and HSR-LBM

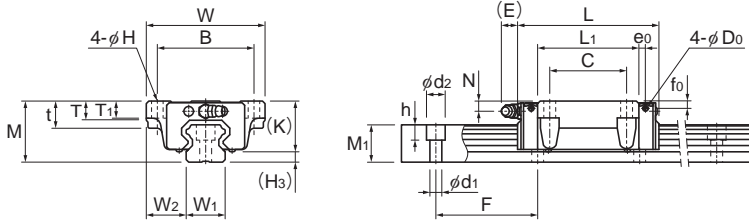

Models HSR15 to 35B/LB/BM/LBM

Model No.	Outer dimensions			LM block dimensions											Pilot hole for side nipple			
	Height	Width	Length	B	C	H	L ₁	t	T	T ₁	K	N	E	Grease nipple	e ₀	f ₀	D ₀	H ₃
	M	W	L	B	C	H	L ₁	t	T	T ₁	K	N	E		e ₀	f ₀	D ₀	H ₃
HSR 15B HSR 15BM	24	47	56.6	38	30	4.5	38.8	11	7	7	19.3	4.3	5.5	PB1021B	3.2	3.9	3	4.7
HSR 20B HSR 20BM	30	63	74	53	40	6	50.8	10	9.5	10	26	5	12	B-M6F	3.1	3.4	3	4
HSR 20LB HSR 20LBM	30	63	90	53	40	6	66.8	10	9.5	10	26	5	12	B-M6F	3.1	3.4	3	4
HSR 25B HSR 25BM	36	70	83.1	57	45	7	59.5	16	11	10	30.5	6	12	B-M6F	3.5	4	3	5.5
HSR 25LB HSR 25LBM	36	70	102.2	57	45	7	78.6	16	11	10	30.5	6	12	B-M6F	3.5	4	3	5.5
HSR 30B HSR 30BM	42	90	98	72	52	9	70.4	18	9	10	35	7	12	B-M6F	5.2	6.2	5.2	7
HSR 30LB HSR 30LBM	42	90	120.6	72	52	9	93	18	9	10	35	7	12	B-M6F	5.2	6.2	5.2	7
HSR 35B HSR 35BM	48	100	109.4	82	62	9	80.4	21	12	13	40.5	8	12	B-M6F	5.5	5.6	5.2	7.5
HSR 35LB HSR 35LBM	48	100	134.8	82	62	9	105.8	21	12	13	40.5	8	12	B-M6F	5.5	5.6	5.2	7.5
HSR 45B HSR 45LB	60	120	139 170.8	100	80	11	98 129.8	25	13	15	50	10	16	B-PT1/8	6.1	6.6	5.2	10
HSR 55B HSR 55LB	70	140	163 201.1	116	95	14	118 156.1	29	13.5	17	57	11	16	B-PT1/8	5.6	7.7	5.2	13
HSR 65B HSR 65LB	90	170	186 245.5	142	110	16	147 206.5	37	21.5	23	76	19	16	B-PT1/8	—	—	—	14
HSR 85B HSR 85LB	110	215	245.6 303	185	140	18	178.6 236	55	28	30	94	23	16	B-PT1/8	—	—	—	16

Model number coding

HSR25 B 2 QZ UU C0 M +1200L P T M - II

Model number

Type of LM block

With QZ Lubricator

Contamination protection accessory symbol (*1)

Stainless steel LM block

LM rail length (in mm)

Stainless steel LM rail

Symbol for LM rail jointed use

Symbol for No. of rails used on the same plane (*4)

No. of LM blocks used on the same rail

Radial clearance symbol (*2)

Normal (No symbol)

Light preload (C1)

Medium preload (C0)

Accuracy symbol (*3)

Normal grade (No Symbol)/High accuracy grade (H)

Precision grade (P)/Super precision grade (SP)

Ultra precision grade (UP)

(*1) See contamination protection accessory on **A1-516**. (*2) See **A1-72**. (*3) See **A1-77**. (*4) See **A1-13**.

Note) This model number indicates that a single-rail unit constitutes one set. (i.e., required number of sets when 2 rails are used in parallel is 2 at a minimum.) Those models equipped with QZ Lubricator cannot have a grease nipple. When desiring a grease nipple for a model attached with QZ, contact THK.

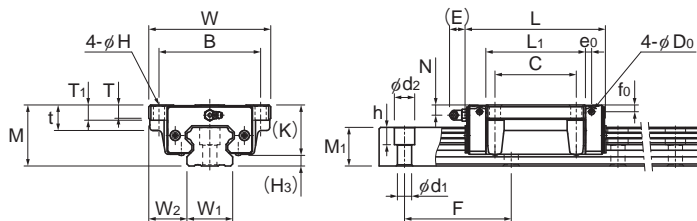

Models HSR45 to 85B/LB

Unit: mm

LM rail dimensions						Basic load rating		Static permissible moment kN•m *					Mass	
Width W_1 ± 0.05	W_2	Height M_1	Pitch F	Length* $d_1 \times d_2 \times h$ Max	C kN	C_0 kN	M_a		M_b		M_c	LM block kg	LM rail kg/m	
							1 block	Double blocks	1 block	Double blocks	1 block			
15	16	15	60	4.5×7.5×5.3 3000 (1240)	10.9	15.7	0.0945	0.527	0.0945	0.527	0.0998	0.2	1.5	
20	21.5	18	60	6×9.5×8.5 3000 (1480)	19.8	27.4	0.218	1.2	0.218	1.2	0.235	0.35	2.3	
20	21.5	18	60	6×9.5×8.5 3000 (1480)	23.9	35.8	0.363	1.87	0.363	1.87	0.307	0.47	2.3	
23	23.5	22	60	7×11×9 3000 (2020)	27.6	36.4	0.324	1.8	0.324	1.8	0.366	0.59	3.3	
23	23.5	22	60	7×11×9 3000 (2020)	35.2	51.6	0.627	3.04	0.627	3.04	0.518	0.75	3.3	
28	31	26	80	9×14×12 3000 (2520)	40.5	53.7	0.599	3.1	0.599	3.1	0.652	1.1	4.8	
28	31	26	80	9×14×12 3000 (2520)	48.9	70.2	0.995	4.89	0.995	4.89	0.852	1.3	4.8	
34	33	29	80	9×14×12 3000 (2520)	53.9	70.2	0.895	4.51	0.895	4.51	1.05	1.6	6.6	
34	33	29	80	9×14×12 3000 (2520)	65	91.7	1.49	7.13	1.49	7.13	1.37	2	6.6	
45	37.5	38	105	14×20×17 3090	82.2 100	101 135	1.5 2.59	8.37 13.4	1.5 2.59	8.37 13.4	1.94 2.6	2.8 3.3	11	
53	43.5	44	120	16×23×20 3060	121 148	146 194	2.6 4.46	14.1 22.7	2.6 4.46	14.1 22.7	3.43 4.56	4.5 5.7	15.1	
63	53.5	53	150	18×26×22 3000	195 249	228 323	5.08 9.81	25 45.6	5.08 9.81	25 45.6	6.2 8.79	8.5 10.7	22.5	
85	65	65	180	24×35×28 3000	304 367	355 464	10.2 16.9	51.2 81	10.2 16.9	51.2 81	12.8 16.7	17 23	35.2	

Note) The maximum length under "Length*" indicates the standard maximum length of an LM rail. (See **A1-204**.)
Static permissible moment* 1 block: the static permissible moment with one LM block

Double blocks: static permissible moment when two LM blocks are in close contact with each other
Overall block length dimension (L) The overall block lengths (L) in the dimension table are for when the contamination protection accessory symbol is UU or SS.
The overall block length (L) will increase if another contamination protection accessory or lubricator is attached.
(See **A1-491** or **A1-512**)

An "M" in the model number indicates the material of the LM block, LM rail, or balls are stainless steel.
Stainless steel products have superior corrosion resistance and environmental resistance.

*The diagram shows the side nipple pilot holes for when a grease nipple is desired for a product with LaCS or a QZ Lubricator.
In all other cases, the side nipple pilot holes will not be through holes.
Consult with THK if you desire drilling for grease nipple mounting.

Models HSR-YR, HSR-YRM and HSR-XYR

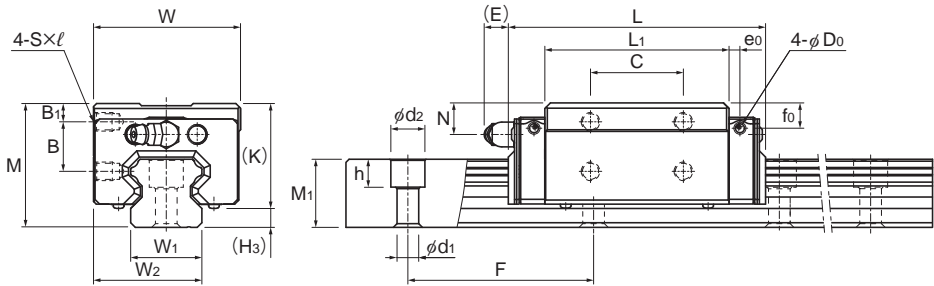

Models HSR15 to 35YR/YRM

Model No.	Outer dimensions			LM block dimensions										Pilot hole for side nipple			H ₃
	Height	Width	Length	B ₁	B	C	S × l	L ₁	K	N	E	Grease nipple	e ₀	f ₀	D ₀		
	M	W	L														
HSR 15YR HSR 15YRM	28	33.5	56.6	4.3	11.5	18	M4 × 5	38.8	23.3	8.3	5.5	PB1021B	3.2	7.9	3	4.7	
HSR 20YR HSR 20YRM	30	43.5	74	4	11.5	25	M5 × 6	50.8	26	5	12	B-M6F	3.1	3.4	3	4	
HSR 25YR HSR 25YRM	40	47.5	83.1	6	16	30	M6 × 6	59.5	34.5	10	12	B-M6F	3.5	8	3	5.5	
HSR 30YR HSR 30YRM	45	59.5	98	8	16	40	M6 × 9	70.4	38	10	12	B-M6F	5.2	9.2	5.2	7	
HSR 35YR HSR 35YRM	55	69.5	109.4	8	23	43	M8 × 10	80.4	47.5	15	12	B-M6F	5.5	12.6	5.2	7.5	
HSR 45YR	70	85.5	139	10	30	55	M10 × 14	98	60	20	16	B-PT1/8	6.1	16.6	5.2	10	
HSR 55YR	80	99.5	163	12	32	70	M12 × 15	118	67	21	16	B-PT1/8	5.6	17.7	5.2	13	
HSR 65XYR	90	124.5	190.5	12	35	85	M16 × 22	138.5	76	19	16	B-PT1/8	6.8	14.6	5.2	14	
HSR 65YR	90	124.5	186	12	35	85	M16 × 22	147	76	19	16	B-PT1/8	—	—	—	14	

Model number coding

HSR25 YR 2 UU C0 M +1200L P T M - II

Model number

Type of LM block

Contamination protection accessory symbol (*1)

Stainless steel LM block

LM rail length (in mm)

Stainless steel LM rail

Symbol for No. of rails used on the same plane (*4)

No. of LM blocks used on the same rail

Radial clearance symbol (*2)
Normal (No symbol)
Light preload (C1)
Medium preload (C0)

Accuracy symbol (*3)
Normal grade (No Symbol)/High accuracy grade (H)
Precision grade (P)/Super precision grade (SP)
Ultra precision grade (UP)

Symbol for LM rail jointed use

(*1) See contamination protection accessory on **A1-516**. (*2) See **A1-72**. (*3) See **A1-77**. (*4) See **A1-13**.

Note) This model number indicates that a single-rail unit constitutes one set. (i.e., required number of sets when 2 rails are used in parallel is 2 at a minimum.)

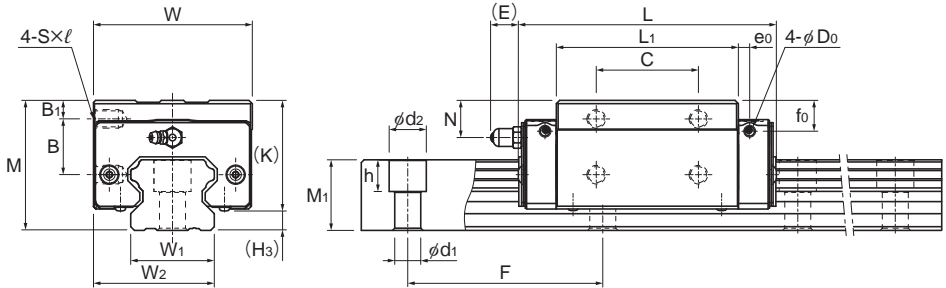

Models HSR45 to 65YR/XYR

Unit: mm

LM rail dimensions						Basic load rating		Static permissible moment $\text{kN}\cdot\text{m}^*$						Mass	
Width W_1 ± 0.05	W_2	Height M_1	Pitch F	$d_1 \times d_2 \times h$	Length* Max	C kN	C_0 kN	M_A		M_B		M_C		LM block kg	LM rail kg/m
								1 block	Double blocks	1 block	Double blocks	1 block	Double blocks		
15	24	15	60	$4.5 \times 7.5 \times 5.3$	3000 (1240)	10.9	15.7	0.0945	0.527	0.0945	0.527	0.0998	0.18	1.5	
20	31.5	18	60	$6 \times 9.5 \times 8.5$	3000 (1480)	19.8	27.4	0.218	1.2	0.218	1.2	0.235	0.25	2.3	
23	35	22	60	$7 \times 11 \times 9$	3000 (2020)	27.6	36.4	0.324	1.8	0.324	1.8	0.366	0.54	3.3	
28	43.5	26	80	$9 \times 14 \times 12$	3000 (2520)	40.5	53.7	0.599	3.1	0.599	3.1	0.652	0.9	4.8	
34	51.5	29	80	$9 \times 14 \times 12$	3000 (2520)	53.9	70.2	0.895	4.51	0.895	4.51	1.05	1.5	6.6	
45	65	38	105	$14 \times 20 \times 17$	3090	82.2	101	1.5	8.37	1.5	8.37	1.94	2.6	11	
53	76	44	120	$16 \times 23 \times 20$	3060	121	146	2.6	14.1	2.6	14.1	3.43	4.3	15.1	
63	93	53	150	$18 \times 26 \times 22$	3000	195	228	5.08	25	5.08	25	6.2	7.3	22.5	
63	93	53	150	$18 \times 26 \times 22$	3000	195	228	5.08	25	5.08	25	6.2	7.3	22.5	

Note) See [A1-455](#) or [A1-457](#) for how to install the HSR-YR and HSR-YRM.

The maximum length under "Length*" indicates the standard maximum length of an LM rail. (See [A1-204](#).)

Static permissible moment* 1 block: the static permissible moment with one LM block

Double blocks: static permissible moment when two LM blocks are in close contact with each other
Total block length L : The total block length L shown in the table is the length with the dust proof parts, code UU or SS.
If other contamination protection accessories or lubricant equipment are installed, the total block length will increase.
(See [A1-491](#) or [A1-512](#))

The M in the model number symbol indicates that the LM block, LM rail and balls are made of stainless steel. The stainless steel provides excellent corrosion and environmental resistance.

Models HSR-CA, HSR-CAM, HSR-HA, HSR-HAM, HSR-XCA and HSR-XHA

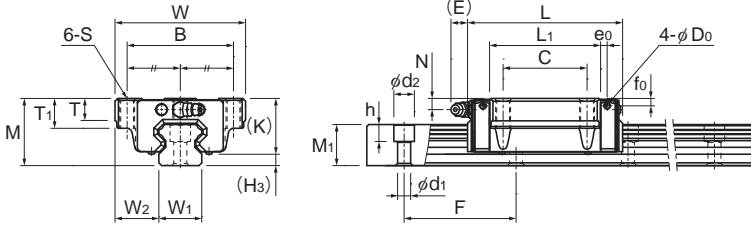

Models HSR20 to 35CA/HA/CAM/HAM

Model No.	Outer dimensions			LM block dimensions											Pilot hole for side nipple			
	Height	Width	Length	B	C	S	L ₁	t	T	T ₁	K	N	E	Grease nipple	e ₀	f ₀	D ₀	H ₃
	M	W	L															
HSR 20CA HSR 20CAM	30	63	74	53	40	M6	50.8	—	9.5	10	26	5	12	B-M6F	3.1	3.4	3	4
HSR 20HA HSR 20HAM	30	63	90	53	40	M6	66.8	—	9.5	10	26	5	12	B-M6F	3.1	3.4	3	4
HSR 25CA HSR 25CAM	36	70	83.1	57	45	M8	59.5	—	11	16	30.5	6	12	B-M6F	3.5	4	3	5.5
HSR 25HA HSR 25HAM	36	70	102.2	57	45	M8	78.6	—	11	16	30.5	6	12	B-M6F	3.5	4	3	5.5
HSR 30CA HSR 30CAM	42	90	98	72	52	M10	70.4	—	9	18	35	7	12	B-M6F	5.2	6.2	5.2	7
HSR 30HA HSR 30HAM	42	90	120.6	72	52	M10	93	—	9	18	35	7	12	B-M6F	5.2	6.2	5.2	7
HSR 35CA HSR 35CAM	48	100	109.4	82	62	M10	80.4	—	12	21	40.5	8	12	B-M6F	5.5	5.6	5.2	7.5
HSR 35HA HSR 35HAM	48	100	134.8	82	62	M10	105.8	—	12	21	40.5	8	12	B-M6F	5.5	5.6	5.2	7.5
HSR 45CA HSR 45HA	60	120	139 170.8	100	80	M12	98 129.8	25	13	15	50	10	16	B-PT1/8	6.1	6.6	5.2	10
HSR 55CA HSR 55HA	70	140	163 201.1	116	95	M14	118 156.1	29	13.5	17	57	11	16	B-PT1/8	5.6	7.7	5.2	13
HSR 65XCA HSR 65XHA	90	170	190.5 250	142	110	M16	138.5 198	37	21.5	23	76	19	16	B-PT1/8	6.8	14.6	5.2	14
HSR 65CA HSR 65HA	90	170	186 245.5	142	110	M16	147 206.5	37	21.5	23	76	19	16	B-PT1/8	—	—	—	14
HSR 85CA HSR 85HA	110	215	245.6 303	185	140	M20	178.6 236	55	28	30	94	23	16	B-PT1/8	—	—	—	16

Model number coding

HSR25 HA 2 QZ KKHH C0 M +1300L P T M - II

Model number

Type of LM block

With QZ Lubricator

Contamination protection accessory symbol (*1)

Stainless steel LM block

LM rail length (in mm)

Stainless steel LM rail

No. of LM blocks used on the same rail

Radial clearance symbol (*2)
Normal (No symbol)
Light preload (C1)
Medium preload (C0)Accuracy symbol (*3)
Normal grade (No Symbol)
High accuracy grade (H)
Precision grade (P)
Super precision grade (SP)
Ultra precision grade (UP)

Symbol for LM rail jointed use

Symbol for No. of rails used on the same plane (*4)

(*1) See contamination protection accessory on **A1-516**. (*2) See **A1-72**. (*3) See **A1-77**. (*4) See **A1-13**.

Note) This model number indicates that a single-rail unit constitutes one set. (i.e., required number of sets when 2 rails are used in parallel is 2 at a minimum.)

Those models equipped with QZ Lubricator cannot have a grease nipple. When desiring a grease nipple for a model attached with QZ, contact THK.

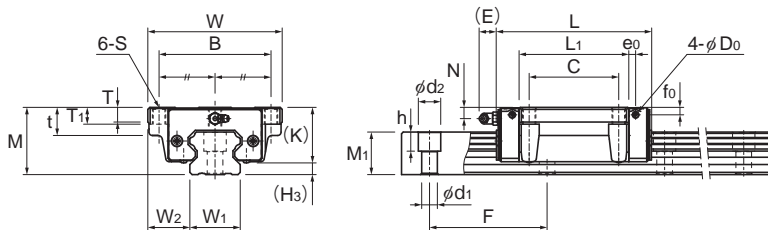

Models HSR45 to 85CA/HA/XCA/XHA

Unit: mm

LM rail dimensions							Basic load rating		Static permissible moment kN•m*					Mass	
Width W_1 ± 0.05	W_2	Height M_1	Pitch F	$d_1 \times d_2 \times h$	Length* Max	C kN	C_0 kN	M_a		M_b		M_c	LM block kg	LM rail kg/m	
								1 block	Double blocks	1 block	Double blocks				1 block
20	21.5	18	60	6×9.5×8.5	3000 (1480)	19.8	27.4	0.218	1.2	0.218	1.2	0.235	0.35	2.3	
20	21.5	18	60	6×9.5×8.5	3000 (1480)	23.9	35.8	0.363	1.87	0.363	1.87	0.307	0.47	2.3	
23	23.5	22	60	7×11×9	3000 (2020)	27.6	36.4	0.324	1.8	0.324	1.8	0.366	0.59	3.3	
23	23.5	22	60	7×11×9	3000 (2020)	35.2	51.6	0.627	3.04	0.627	3.04	0.518	0.75	3.3	
28	31	26	80	9×14×12	3000 (2520)	40.5	53.7	0.599	3.1	0.599	3.1	0.652	1.1	4.8	
28	31	26	80	9×14×12	3000 (2520)	48.9	70.2	0.995	4.89	0.995	4.89	0.852	1.3	4.8	
34	33	29	80	9×14×12	3000 (2520)	53.9	70.2	0.895	4.51	0.895	4.51	1.05	1.6	6.6	
34	33	29	80	9×14×12	3000 (2520)	65	91.7	1.49	7.13	1.49	7.13	1.37	2	6.6	
45	37.5	38	105	14×20×17	3090	82.2 100	101 135	1.5 2.59	8.37 13.4	1.5 2.59	8.37 13.4	1.94 2.6	2.8 3.3	11	
53	43.5	44	120	16×23×20	3060	121 148	146 194	2.6 4.46	14.1 22.7	2.6 4.46	14.1 22.7	3.43 4.56	4.5 5.7	15.1	
63	53.5	53	150	18×26×22	3000	195 249	228 323	5.08 9.81	25 45.6	5.08 9.81	25 45.6	6.2 8.79	8.5 10.7	22.5	
63	53.5	53	150	18×26×22	3000	195 249	228 323	5.08 9.81	25 45.6	5.08 9.81	25 45.6	6.2 8.79	8.5 10.7	22.5	
85	65	65	180	24×35×28	3000	304 367	355 464	10.2 16.9	51.2 81	10.2 16.9	51.2 81	12.8 16.7	17 23	35.2	

Note) The maximum length under "Length*" indicates the standard maximum length of an LM rail. (See [A1-204](#).)

Static permissible moment* 1 block: the static permissible moment with one LM block

Double blocks: static permissible moment when two LM blocks are in close contact with each other

Total block length L

: The total block length L shown in the table is the length with the dust proof parts, code UU or SS.

If other contamination protection accessories or lubricant equipment are installed, the total block length will increase.

(See [A1-491](#) or [A1-512](#))

The M in the model number symbol indicates that the LM block, LM rail and balls are made of stainless steel. The stainless steel provides excellent corrosion and environmental resistance.

Models HSR-CB, HSR-CBM, HSR-HB, HSR-HBM, HSR-XCB and HSR-XHB

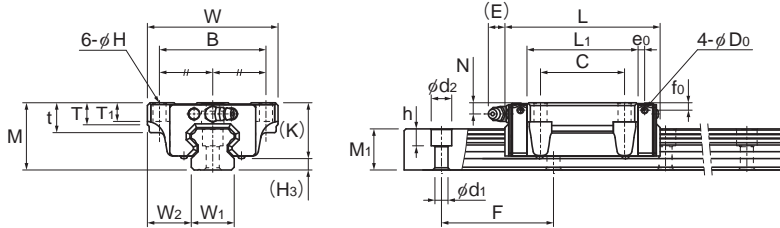

Models HSR20 to 35CB/HB/CBM/HBM

Model No.	Outer dimensions			LM block dimensions											Pilot hole for side nipple			
	Height	Width	Length	B	C	H	L ₁	t	T	T ₁	K	N	E	Grease nipple	e ₀	f ₀	D ₀	H ₃
	M	W	L	B	C	H	L ₁	t	T	T ₁	K	N	E		e ₀	f ₀	D ₀	H ₃
HSR 20CB HSR 20CBM	30	63	74	53	40	6	50.8	10	9.5	10	26	5	12	B-M6F	3.1	3.4	3	4
HSR 20HB HSR 20HBM	30	63	90	53	40	6	66.8	10	9.5	10	26	5	12	B-M6F	3.1	3.4	3	4
HSR 25CB HSR 25CBM	36	70	83.1	57	45	7	59.5	16	11	10	30.5	6	12	B-M6F	3.5	4	3	5.5
HSR 25HB HSR 25HBM	36	70	102.2	57	45	7	78.6	16	11	10	30.5	6	12	B-M6F	3.5	4	3	5.5
HSR 30CB HSR 30CBM	42	90	98	72	52	9	70.4	18	9	10	35	7	12	B-M6F	5.2	6.2	5.2	7
HSR 30HB HSR 30HBM	42	90	120.6	72	52	9	93	18	9	10	35	7	12	B-M6F	5.2	6.2	5.2	7
HSR 35CB HSR 35CBM	48	100	109.4	82	62	9	80.4	21	12	13	40.5	8	12	B-M6F	5.5	5.6	5.2	7.5
HSR 35HB HSR 35HBM	48	100	134.8	82	62	9	105.8	21	12	13	40.5	8	12	B-M6F	5.5	5.6	5.2	7.5
HSR 45CB HSR 45HB	60	120	139 170.8	100	80	11	98 129.8	25	13	15	50	10	16	B-PT1/8	6.1	6.6	5.2	10
HSR 55CB HSR 55HB	70	140	163 201.1	116	95	14	118 156.1	29	13.5	17	57	11	16	B-PT1/8	5.6	7.7	5.2	13
HSR 65XCB HSR 65XHB	90	170	190.5 250	142	110	16	138.5 198	37	21.5	23	76	19	16	B-PT1/8	6.8	14.6	5.2	14
HSR 65CB HSR 65HB	90	170	186 245.5	142	110	16	147 206.5	37	21.5	23	76	19	16	B-PT1/8	—	—	—	14
HSR 85CB HSR 85HB	110	215	245.6 303	185	140	18	178.6 236	55	28	30	94	23	16	B-PT1/8	—	—	—	16

Model number coding

HSR35 CB 2 QZ ZZHH C0 M +1400L P T M - II

Model number

Type of LM block

With QZ Lubricator

Contamination protection accessory symbol (*1)

Stainless steel LM block

LM rail length (in mm)

Stainless steel LM rail

No. of LM blocks used on the same rail

Radial clearance symbol (*2)
Normal (No symbol)
Light preload (C1)
Medium preload (C0)Accuracy symbol (*3)
Normal grade (No Symbol)
High accuracy grade (H)
Precision grade (P)
Super precision grade (SP)
Ultra precision grade (UP)

Symbol for LM rail jointed use

Symbol for No. of rails used on the same plane (*4)

(*1) See contamination protection accessory on **A1-516**. (*2) See **A1-72**. (*3) See **A1-77**. (*4) See **A1-13**.

Note) This model number indicates that a single-rail unit constitutes one set. (i.e., required number of sets when 2 rails are used in parallel is 2 at a minimum.)

Those models equipped with QZ Lubricator cannot have a grease nipple. When desiring a grease nipple for a model attached with QZ, contact THK.

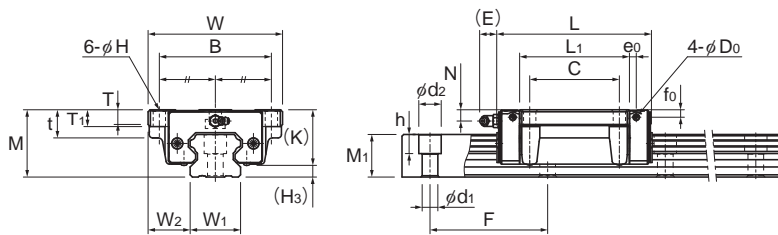

Models HSR45 to 85CB/HB/XCB/XHB

Unit: mm

LM rail dimensions						Basic load rating		Static permissible moment $\text{kN}\cdot\text{m}^*$					Mass	
Width W_1 ± 0.05	W_2	Height M_1	Pitch F	$d_1 \times d_2 \times h$	Length* Max	C kN	C_0 kN	M_a		M_b		M_c	LM block kg	LM rail kg/m
								1 block	Double blocks	1 block	Double blocks	1 block		
20	21.5	18	60	$6 \times 9.5 \times 8.5$	3000 (1480)	19.8	27.4	0.218	1.2	0.218	1.2	0.235	0.35	2.3
20	21.5	18	60	$6 \times 9.5 \times 8.5$	3000 (1480)	23.9	35.8	0.363	1.87	0.363	1.87	0.307	0.47	2.3
23	23.5	22	60	$7 \times 11 \times 9$	3000 (2020)	27.6	36.4	0.324	1.8	0.324	1.8	0.366	0.59	3.3
23	23.5	22	60	$7 \times 11 \times 9$	3000 (2020)	35.2	51.6	0.627	3.04	0.627	3.04	0.518	0.75	3.3
28	31	26	80	$9 \times 14 \times 12$	3000 (2520)	40.5	53.7	0.599	3.1	0.599	3.1	0.652	1.1	4.8
28	31	26	80	$9 \times 14 \times 12$	3000 (2520)	48.9	70.2	0.995	4.89	0.995	4.89	0.852	1.3	4.8
34	33	29	80	$9 \times 14 \times 12$	3000 (2520)	53.9	70.2	0.895	4.51	0.895	4.51	1.05	1.6	6.6
34	33	29	80	$9 \times 14 \times 12$	3000 (2520)	65	91.7	1.49	7.13	1.49	7.13	1.37	2	6.6
45	37.5	38	105	$14 \times 20 \times 17$	3090	82.2 100	101 135	1.5 2.59	8.37 13.4	1.5 2.59	8.37 13.4	1.94 2.6	2.8 3.3	11
53	43.5	44	120	$16 \times 23 \times 20$	3060	121 148	146 194	2.6 4.46	14.1 22.7	2.6 4.46	14.1 22.7	3.43 4.56	4.5 5.7	15.1
63	53.5	53	150	$18 \times 26 \times 22$	3000	195 249	228 323	5.08 9.81	25 45.6	5.08 9.81	25 45.6	6.2 8.79	8.5 10.7	22.5
63	53.5	53	150	$18 \times 26 \times 22$	3000	195 249	228 323	5.08 9.81	25 45.6	5.08 9.81	25 45.6	6.2 8.79	8.5 10.7	22.5
85	65	65	180	$24 \times 35 \times 28$	3000	304 367	355 464	10.2 16.9	51.2 81	10.2 16.9	51.2 81	12.8 16.7	17 23	35.2

Note) The maximum length under "Length*" indicates the standard maximum length of an LM rail. (See [A1-204](#).)

Static permissible moment* 1 block: the static permissible moment with one LM block

Double blocks: static permissible moment when two LM blocks are in close contact with each other

Total block length L

: The total block length L shown in the table is the length with the dust proof parts, code UU or SS.

If other contamination protection accessories or lubricant equipment are installed, the total block length will increase.

(See [A1-491](#) or [A1-512](#))

The M in the model number symbol indicates that the LM block, LM rail and balls are made of stainless steel. The stainless steel provides excellent corrosion and environmental resistance.

Models HSR-HA, HSR-HB and HSR-HR

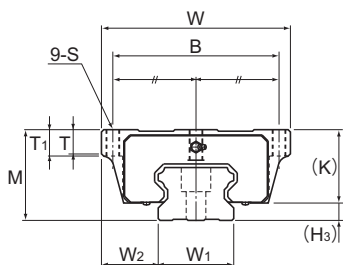

Models HSR100 to 150HA

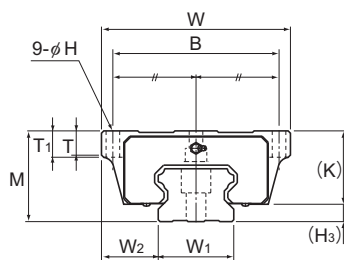

Models HSR100 to 150HB

Model No.	Outer dimensions			LM block dimensions										Grease nipple	H ₃
	Height	Width	Length	B	C	H	S × ℓ	L _i	T	T _i	K	N	E		
	M	W	L												
HSR 100HA HSR 100HB HSR 100HR	120	250 250 200	334	220 220 130	200	20	M18* — M18×27	261	32 32 33	35 35 —	100	23	16	B-PT1/4	20
HSR 120HA HSR 120HB HSR 120HR	130	290 290 220	365	250 250 146	210	22	M20* — M20×30	287	34 34 33.7	38 38 —	110	26.5	16	B-PT1/4	20
HSR 150HA HSR 150HB HSR 150HR	145	350 350 266	396	300 300 180	230	26	M24* — M24×35	314	36 36 33	40 40 —	123	29	16	B-PT1/4	22

Note) "*" indicates a through hole.

Model number coding

HSR150 HR 2 UU C1 +2350L H T - II

Model number

Type of LM block

Contamination protection accessory symbol (*1)

LM rail length (in mm)

Symbol for LM rail jointed use

Symbol for No. of rails used on the same plane (*4)

No. of LM blocks used on the same rail

Radial clearance symbol (*2)
Normal (No symbol)
Light preload (C1)
Medium preload (C0)

Accuracy symbol (*3)
Normal grade (No Symbol)/High accuracy grade (H)
Precision grade (P)/Super precision grade (SP)
Ultra precision grade (UP)

(*1) See contamination protection accessory on [A1-516](#). (*2) See [A1-72](#). (*3) See [A1-77](#). (*4) See [A1-13](#).

Note) This model number indicates that a single-rail unit constitutes one set. (i.e., required number of sets when 2 rails are used in parallel is 2 at a minimum.)

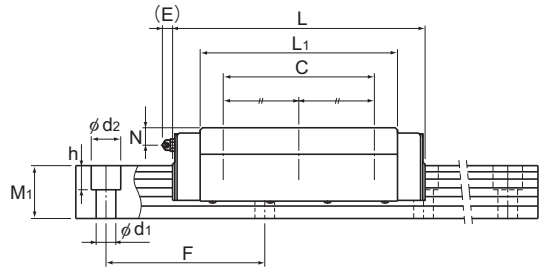
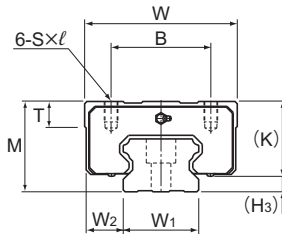

Models HSR100 to 150HR

Unit: mm

		LM rail dimensions					Basic load rating		Static permissible moment kN•m*					Mass	
Width		Height	Pitch		Length*	C	C ₀	M _A		M _B		M _C	LM block	LM rail	
W ₁ ±0.05	W ₂	M ₁	F	d ₁ × d ₂ × h	Max	kN	kN	1 block	Double blocks	1 block	Double blocks	1 block	kg	kg/m	
100	75 75 50	70	210	26 × 39 × 32	3000	441	540	20.7	105	20.7	105	24.1	32	49	
114	88 88 53	75	230	33 × 48 × 43	3000	540	653	27.5	138	27.5	138	33.3	43	61	
144	103 103 61	85	250	39 × 58 × 46	3000	518	728	33.6	167	33.6	167	45.2	62	87	

Note) The maximum length under "Length*" indicates the standard maximum length of an LM rail. (See **A1-204**.)

Static permissible moment* 1 block: the static permissible moment with one LM block

Double blocks: static permissible moment when two LM blocks are in close contact with each other

Total block length L

: The total block length L shown in the table is the length with the dust proof parts, code UU or SS. If other contamination protection accessories or lubricant equipment are installed, the total block length will increase.

(See **A1-491** or **A1-512**)

Standard Length and Maximum Length of the LM Rail

Table1 shows the standard lengths and the maximum lengths of model HSR variations. If the maximum length of the desired LM rail exceeds them, jointed rails will be used. Contact THK for details. For special rail lengths, it is recommended to use a value corresponding to the G,g dimension from the table. As the G,g dimension increases, this portion becomes less stable, and the accuracy performance is severely impacted.

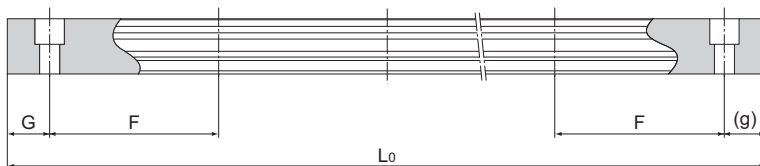

Table1 Standard Length and Maximum Length of the LM Rail for Model HSR

Unit: mm

Model No.	HSR 8	HSR 10	HSR 12	HSR 15	HSR 20	HSR 25	HSR 30	HSR 35	HSR 45	HSR 55	HSR 65	HSR 85	HSR 100	HSR 120	HSR 150
LM rail standard length (L_0)	35	45	70	160	160	220	280	280	570	780	1270	1530	1340	1470	1600
	55	70	110	220	220	280	360	360	675	900	1570	1890	1760	1930	2100
	75	95	150	280	280	340	440	440	780	1020	2020	2250	2180	2390	2350
	95	120	190	340	340	400	520	520	885	1140	2620	2610	2600		
	115	145	230	400	400	460	600	600	990	1260					
	135	170	270	460	460	520	680	680	1095	1380					
	155	195	310	520	520	580	760	760	1200	1500					
	175	220	350	580	580	640	840	840	1305	1620					
	195	245	390	640	640	700	920	920	1410	1740					
	215	270	430	700	700	760	1000	1000	1515	1860					
	235	295	470	760	760	820	1080	1080	1620	1980					
	255	320	510	820	820	940	1160	1160	1725	2100					
	275	345	550	940	940	1000	1240	1240	1830	2220					
		370	590	1000	1000	1060	1320	1320	1935	2340					
		395	630	1060	1060	1120	1400	1400	2040	2460					
		420	670	1120	1120	1180	1480	1480	2145	2580					
		445		1180	1180	1240	1560	1560	2250	2700					
		470		1240	1240	1300	1640	1640	2355	2820					
				1360	1360	1360	1720	1720	2460	2940					
				1480	1480	1420	1800	1800	2565	3060					
				1600	1600	1480	1880	1880	2670						
					1720	1540	1960	1960	2775						
					1840	1600	2040	2040	2880						
					1960	1720	2200	2200	2985						
					2080	1840	2360	2360	3090						
				2200	1960	2520	2520								
					2080	2680	2680								
					2200	2840	2840								
					2320	3000	3000								
					2440										
Standard pitch F	20	25	40	60	60	60	80	80	105	120	150	180	210	230	250
G,g	7.5	10	15	20	20	20	20	20	22.5	30	35	45	40	45	50
Max length	(975)	(995)	(1240)	3000 (1240)	3000 (1480)	3000 (2020)	3000 (2520)	3000 (2520)	3090	3060	3000	3000	3000	3000	3000

Note1) The maximum length varies with accuracy grades. Contact THK for details.

Note2) If jointed rails are not allowed and a greater length than the maximum values above is required, contact THK.

Note3) The figures in the parentheses indicate the maximum lengths of stainless steel made models.

Tapped-hole LM Rail Type of Model HSR

HSR model rails also include a type where the LM rail is tapped from the bottom. This type is useful when mounting from the bottom of the base and when increased contamination protection is desired.

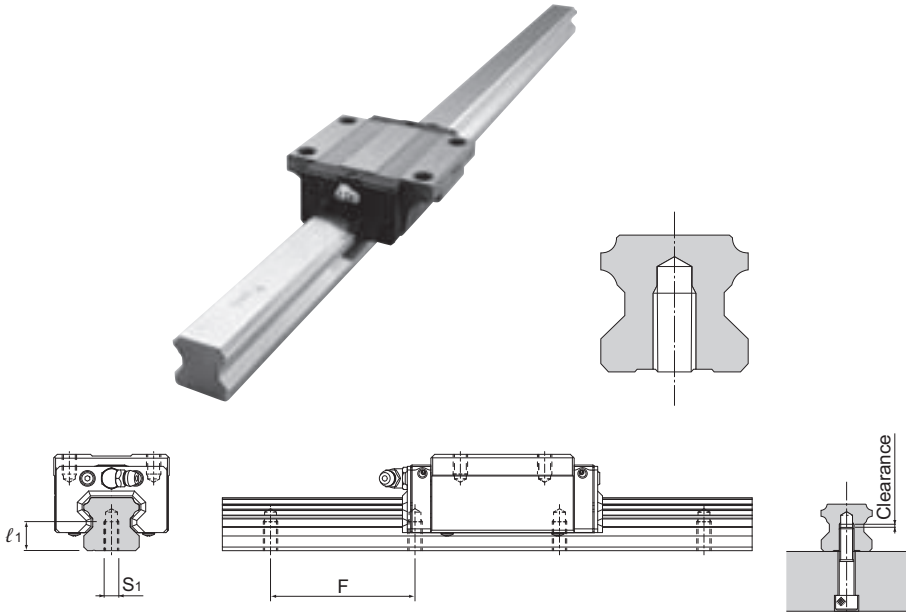

- (1) Determine the bolt length so that a clearance of 2 to 5 mm is secured between the bolt end and the bottom of the tap (effective tap depth). (See figure above.)
- (2) A tapped-hole LM rail type is also available for models HSR-YR and HSR-XYR.
- (3) For standard pitches of the taps, see Table1 on **A1-204**.

Table2 Dimensions of the LM Rail Tap

Unit: mm

Model No.	S ₁	Effective tap depth l_1
HSR 15	M5	8
HSR 20	M6	10
HSR 25	M6	12
HSR 30	M8	15
HSR 35	M8	17
HSR 45	M12	24
HSR 55	M14	24
HSR 65	M20	30

Model number coding

HSR30A2UU +1000LH K

↑
Symbol for
tapped-hole LM rail type

Prevention of LM block from falling off of LM rail

In miniature model HSR, the balls fall out if the LM block comes off the LM rail.

For this reason, LM Guide assemblies are delivered with a part which prevents the LM block from coming off the rail. If you remove this part when using the product, please take precautions to avoid overrunning the blocks off of the rail.

Greasing Hole

[Greasing Hole for Model HSR]

The Model HSR LM block can be greased from the side or top surface. In order to prevent foreign material from entering the LM block, greasing holes are not through holes in blocks with regular specifications. Contact THK if these will be used.

In addition, contact THK if you will use an upper surface greasing hole with a Model HSR-R, HSR-XR, HSR-LR, HSR-XLR, HSR-YR, or HSR-XYR, as a lubrication adapter is required.

The lubricant may not reach the raceway if the LM Guide is not installed in a horizontal orientation.

Be sure to let THK know the mounting orientation and the position where the grease nipple or plumbing fixture will be attached to each LM block.

See **A1-12** for the mounting orientation and **A24-2** for lubrication.

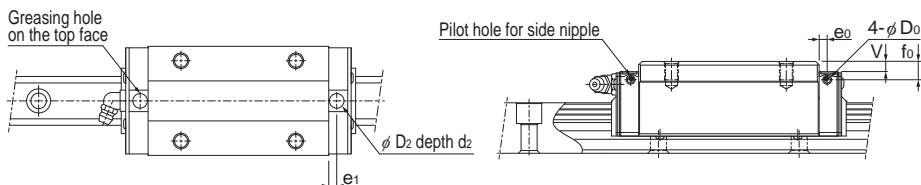

Unit: mm

Model No.	Pilot hole for side nipple			Applicable nipple	Greasing hole on the top face				
	e_0	f_0	D_0		D_2	(O-ring)	V	e_1	d_2
HSR	15C	3.2	3.9	3	5.1	SS4	0.3	3.2	0.65
	15LC								
	15A								
	15B								
	15CA								
	15HA								
	15CB								
	15HB								
	15R	3.2	7.9	3	6	SS5	0.2	4.3	0.6
	15LR								
	15YR								
	20C	3.1	3.4	3	6	SS5	0.2	4.3	0.6
	20LC								
	20A								
20LA									
20B									
20LB									
20CA									
20HA									
20CB									
20HB									
20R	3.1	3.4	3	6	SS5	0.2	4.3	0.6	
20LR									
20YR									

Model No.		Pilot hole for side nipple			Applicable nipple	Greasing hole on the top face				
		e ₀	f ₀	D ₀		D ₂	(O-ring)	V	e ₁	d ₂
HSR	25C 25LC 25A 25LA 25B 25LB 25CA 25HA 25CB 25HB	3.5	4	3	PB107	6.2	P3	0.4	3.9	1
	25R 25LR 25YR	3.5	8	3				4.4		
	30C 30LC 30A 30LA 30B 30LB 30CA 30HA 30CB 30HB	5.2	6.2	5.2				M6F		
	30R 30LR 30YR	5.2	9.2	5.2	3.4					
	35C 35LC 35A 35LA 35B 35LB 35CA 35HA 35CB 35HB	5.5	5.6	5.2	6.2	P3	0.4		5.5	1
	35R 35LR 35YR	5.5	12.6	5.2			7.4			
	45C 45LC 45A 45LA 45B 45LB 45CA 45HA 45CB 45HB	6.1	6.6	5.2			10.2	P7		
	45R 45LR 45YR	6.1	16.6	5.2	10.4					
	55C 55LC 55A 55LA 55B 55LB 55CA 55HA 55CB 55HB	5.6	7.7	5.2	10.2	P7			0.4	9.1
	55R 55LR 55YR	5.6	17.7	5.2			10.4			

Model No.		Pilot hole for side nipple			Applicable nipple	Greasing hole on the top face				
		e_0	f_0	D_0		D_2	(O-ring)	V	e_1	d_2
HSR	65XC	6.8	14.6	5.2	M6F	10.2	P7	5.9	9.5	1
	65XLC							5.9		
	65XR	6.8	14.6	5.2				5.9		
	65XLR							5.9		
65XYR										

*Upper surface lubrication is for oil lubrication only. Contact THK if you are considering using the greasing hole on the top face for grease lubrication.

[Semi-standard Greasing Hole for Model HSR]

For model HSR, a semi-standard greasing hole is available. Specify the appropriate model number according to the application.

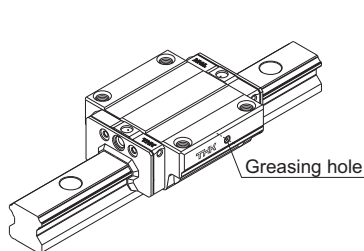

Type with a Greasing Hole Drilled on the Side Surface

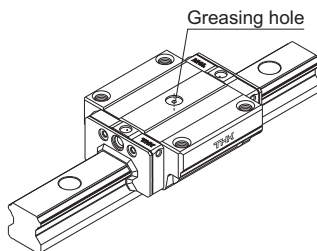

Type with a Greasing Hole Drilled on the Top Face

