



NEW

Compact Ball Spline

LT-X / LT-XL / LF-X / LF-XL

Nut outer diameter dimension equivalent to that of the linear bushing
Stable operation with little fluctuation of the rolling resistance



For details, visit THK at www.thk.com

*Product information is updated regularly on the THK website.

Compact Ball Spline

LT-X / LT-XL / LF-X / LF-XL

Enable a high rigidity, high speed and compact machine

Compact nut shape

The nut shape is more compact than that of the existing model number LT/LF thanks to new circulation path.
Also the nut outer diameter is the same as that of the linear bushing.

●Nut dimension comparison (LT-X/Linear bushing LM/LT) Unit: mm

Shaft diameter	Outer diameter			Overall Length		
	Model LT-X	Model LM	Model LT	Model LT-X	Model LM	Model LT
4	8	8	10	12	12	16
5	10	10	12	13.6	15	20
6	12	12	14	17.6	19	25
8	15	15	16	23.8	24	25
10	19	19	21	30.8	29	33
13	23	23	24	32.4	32	36
16	28	28	31	46.4	37	50
20	32	32	35	59	42	63
25	40	40	42	67	59	71
30	45	45	47	75.6	64	80

●Nut dimension comparison (LT-XL/Linear bushing LM-L/LT) Unit: mm

Shaft diameter	Outer diameter			Overall Length		
	Model LT-XL	Model LM-L	Model LT	Model LT-XL	Model LM-L	Model LT
5	10	10	—	24.6	29	—
6	12	12	—	28.6	35	—
8	15	15	—	35.6	45	—

Model LT-X

(comparison with our existing Model LT)

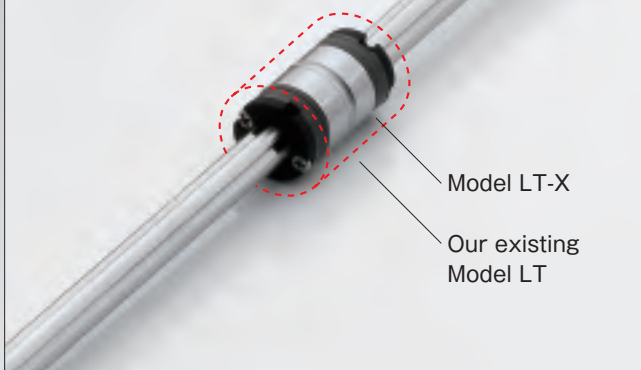

Model LT-X / LT-XL

Cylindrical Type Model LT-X

The most compact type with a straight cylindrical nut. When transmitting a torque, a key is driven into the body.

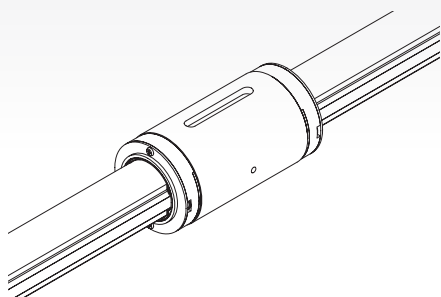

Cylindrical Type Long Type - Model LT-XL

Type with the same outer diameter as and longer nut than model LT-X. [LT5XL, LT6XL, LT8XL]

This is suitable for cases that torque, overhang load, or moment over the corresponding allowable value of model LT-X is applied.

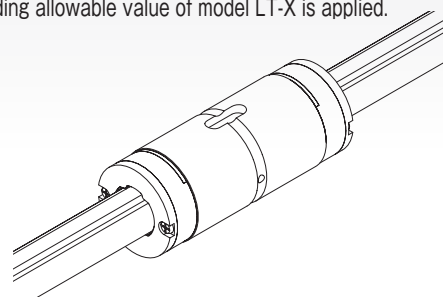

High-rigidity design

The rigidity can be improved because the spline shaft diameter is larger by one size with the equivalent nut outer diameter compared than that of the existing model number LT/LF.

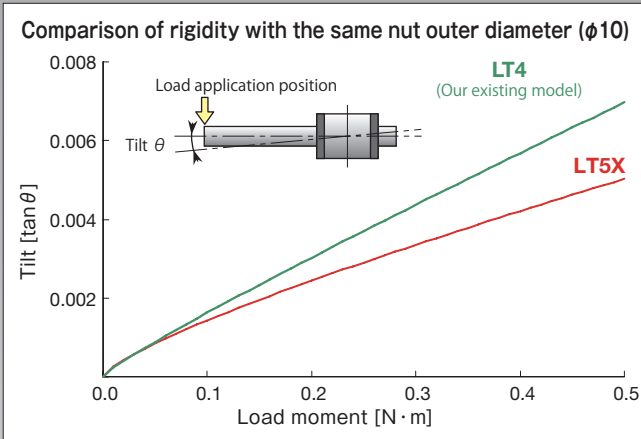

High-speed support

The optimal ball circulation with new circulation path achieves high-speed operation.

High Speed Durability Test

● Test method

Item	Description
Model tested	LT20X
Speed	2m/s
Acceleration	49m/s ²
Lubricant	Lithium soap group grease (AFB-LF grease)
Stroke	650mm
Posture	Horizontal

● Test result

No anomaly after travelling 10,000 km

Smooth Motion

The fluctuation of the rolling resistance is smaller than that of the existing model number LT/LF.

Rolling resistance value measurement test

● Test method

Item	Description
Model tested	LT16X / LT16
Speed	10mm/s
Lubricant	Lithium soap group grease (AFB-LF grease)
Posture	Horizontal

● Test result

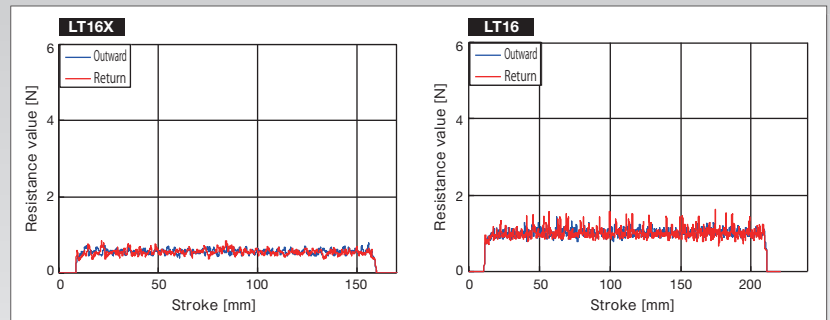

Model LF-X / LF-XL

Flanged Type - Model LF-X

The spline nut can be attached to the housing via the flange, making assembly simple. It is suitable for locations where the housing may be deformed if a keyway is machined on its surface, and where the housing width is small.

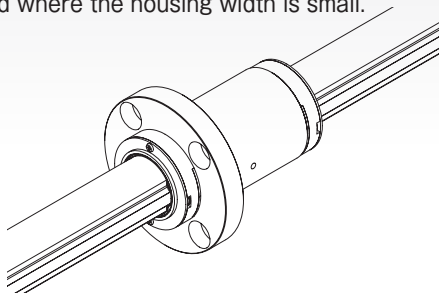

Flanged Long Type - Model LF-XL

Type with the same outer diameter as and with longer nut than model LF-X. [LF5XL, LF6XL, LF8XL]

This is suitable for cases that torque, overhang load, or moment over the corresponding allowable value of model LF-X is applied.

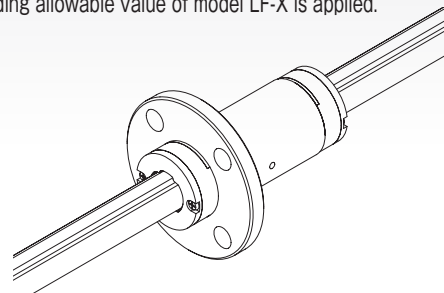

Accuracy Standards

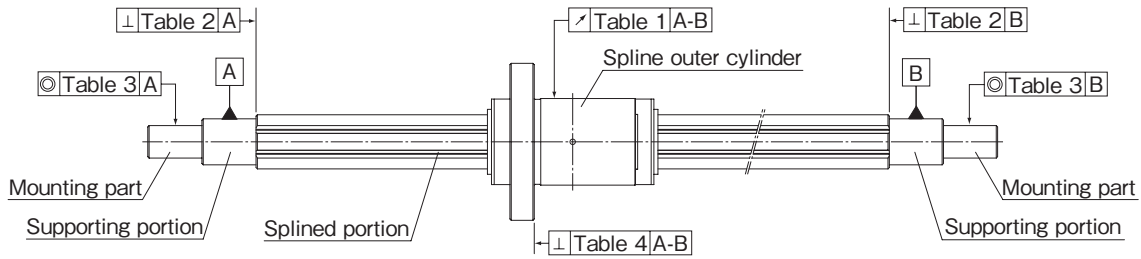

Fig.1 Accuracy Measurement Items of the Ball Spline

Table 1 Runout of the Spline outer Cylinder Circumference in Relation to the Support of the Spline Shaft

Nominal shaft diameter		Runout (max) [μm]														
		4,5			6,8			10			13,16,20			25,30		
Overall spline shaft length (mm)		Normal grade	High-accuracy grade	Precision grade	Normal grade	High-accuracy grade	Precision grade	Normal grade	High-accuracy grade	Precision grade	Normal grade	High-accuracy grade	Precision grade	Normal grade	High-accuracy grade	Precision grade
Above	Or Less															
—	200	72	46	26	72	46	26	59	36	20	56	34	18	53	32	18
200	315	133*1	—	—	133	89*2	57*3	83	54	32	71	45	25	58	39	21
315	400	—	—	—	171	114	—	103	68	41	83	53	31	70	44	25
400	500	—	—	—	214	—	—	123	82	51	95	62	38	78	50	29
500	630	—	—	—	—	—	—	151	102	—	112	75	46	88	57	34
630	800	—	—	—	—	—	—	190	—	—	137	92	58	103	68	42
800	1000	—	—	—	—	—	—	—	—	—	170	115	75	124	83	52
1000	1250	—	—	—	—	—	—	—	—	—	—	—	—	151	102	65
1250	1600	—	—	—	—	—	—	—	—	—	—	—	—	190	130	85

*1 #4 is excluded. #5 applied up to 250mm. *2 #6 applied up to 250mm. *3 #6 is excluded.

Table 2 Perpendicularity of the Supporting Portion in Relation to the Support of the Spline Shaft

Accuracy	Perpendicularity (MAX) [μm]			
	Nominal shaft diameter	Normal grade	High accuracy grade (H)	Precision grade (P)
4,5,6,8,10		22	9	6
13,16,20		27	11	8
25,30		33	13	9

Table 3 Concentricity of the Part-mounting in Relation to the Support of the Spline Shaft

Accuracy	Concentricity (MAX) [μm]			
	Nominal shaft diameter	Normal grade	High accuracy grade (H)	Precision grade (P)
4,5,6,8		33	14	8
10		41	17	10
13,16,20		46	19	12
25,30		53	22	13

Table 4 Perpendicularity of the Flange-mounting Surface of the Spline outer cylinder in Relation to the Support of the Spline Shaft

Accuracy	Perpendicularity (MAX) [μm]			
	Nominal shaft diameter	Normal grade	High accuracy grade (H)	Precision grade (P)
4,5,6,8		27	11	8
10,13		33	13	9
16,20,25,30		39	16	11

*Applied only to model LF-X

Clearance in the rotational direction

In models LT-X/LT-XL and LF-X/LF-XL, the sum of the clearances of circumferential direction is standardized as the clearance in the rotational direction.

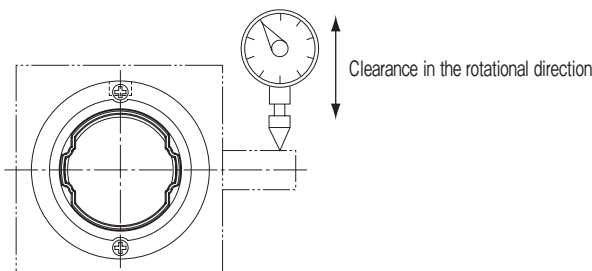

Fig.2 Measurement of Clearance in the Rotational Direction

Table 5 Clearance in the Rotational Direction

Unit: μm

Nominal shaft diameter	Clearance in the rotational direction		
	Normal	CL clearance	CM clearance
4	-2 to +1	-6 to -2	—
5	-2 to +1	-6 to -2	—
6	-2 to +1	-6 to -2	—
8	-2 to +1	-6 to -2	—
10	-2 to +1	-4 to -2	—
13	-2 to +1	-4 to -2	—
16	-2 to +1	-5 to -2	-8 to -5
20	-2 to +1	-5 to -2	-8 to -5
25	-3 to +1	-7 to -3	-11 to -7
30	-3 to +1	-7 to -3	-11 to -7

Sectional Shape of the Spline Shaft

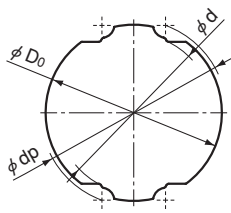

Sectional shape of the Spline Shaft

Unit: mm

Nominal shaft diameter		4	5	6	8	10	13	16	20	25	30
Minor diameter	ϕd	3.6	4.5	5.4	7	8.6	11.3	13.9	17.9	22.4	27
Major diameter	ϕD_0	4	5	6	8	10	13	16	20	25	30
Ball Center-to-center Diameter	ϕdp	4.4	5.5	6.6	8.6	10.7	13.8	17.1	21.1	26.4	31.6
Mass (g/m)		100	150	210	380	590	1010	1520	2410	3710	5370

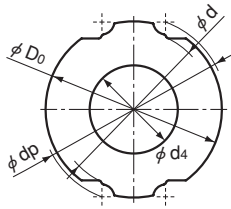

Sectional shape of Hollow Spline Shaft (Type K)

Unit: mm

Nominal shaft diameter		4	5	6	8	10	13	16	20	25	30
Minor diameter	ϕd	—	—	—	—	8.6	11.3	13.9	17.9	22.4	27
Major diameter	ϕD_0	—	—	—	—	10	13	16	20	25	30
Ball Center-to-center Diameter	ϕdp	—	—	—	—	10.7	13.8	17.1	21.1	26.4	31.6
Hole diameter	ϕd_4	—	—	—	—	4	5	7	10	12	16
Mass (g/m)		—	—	—	—	490	850	1220	1790	2820	3780

Type K (Thick)

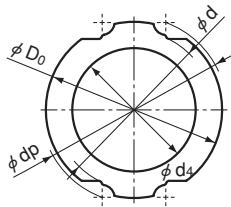

Sectional shape of Hollow Spline Shaft (Type N)

Unit: mm

Nominal shaft diameter		4	5	6	8	10	13	16	20	25	30
Minor diameter	ϕd	—	—	—	—	—	—	13.9	17.9	22.4	27
Major diameter	ϕD_0	—	—	—	—	—	—	16	20	25	30
Ball Center-to-center Diameter	ϕdp	—	—	—	—	—	—	17.1	21.1	26.4	31.6
Hole diameter	ϕd_4	—	—	—	—	—	—	11	14	18	21
Mass (g/m)		—	—	—	—	—	—	770	1190	1700	2630

Type N (Thin)

Fig.3 Sectional Shape of the Spline Shaft

Table 6 shows the section modulus (Z), polar section modulus (Zp), polar moment of inertia (Ip), and moment of inertia (I) of the spline shaft.

Table 6 Cross-sectional Characteristics of the Spline Shaft

Nominal shaft diameter		Section modulus $Z \text{ mm}^3$	Polar section modulus $Z_p \text{ mm}^3$	Polar moment of inertia $I_p \text{ mm}^4$	Moment of inertia $I \text{ mm}^4$
4	Solid	5.7	11.8	23.2	11.2
5	Solid	11.3	23.3	57.2	27.7
6	Solid	19.6	40.4	119.1	57.7
8	Solid	45.0	93.9	366.2	175.6
10	Solid	86.5	183.8	896.9	422.3
	Type K	84.0	178.6	871.7	409.7
13	Solid	191.3	405.3	2574.6	1215.3
	Type K	186.5	395.6	2513.2	1184.6
16	Solid	350.8	749.7	5844.5	2734.3
	Type K	335.6	719.5	5608.8	2616.4
	Type N	258.6	565.4	4407.2	2015.6
20	Solid	716.5	1498.5	14731.7	7043.9
	Type K	666.6	1398.7	13749.9	6553.0
	Type N	524.7	1114.9	10960.2	5158.1
25	Solid	1404.2	2932.9	36067.4	17268.2
	Type K	1321.4	2767.4	34031.6	16250.3
	Type N	985.2	2094.8	25761.4	12115.2
30	Solid	2444.1	5086.3	75160.0	36115.8
	Type K	2226.4	4650.9	68726.1	32898.8
	Type N	1798.0	3794.2	56067.4	26569.7

Strength Design of the Spline Shaft

The spline shaft is a compound shaft capable of receiving a radial load and torque. When the load and torque are large, the spline shaft strength must be taken into account.

[Spline Shaft Receiving a Bending Load]

When a bending load is applied to the spline shaft, obtain the spline shaft diameter using the equation (1) below.

$$M = \sigma \cdot Z \text{ and } Z = \frac{M}{\sigma} \dots\dots\dots (1)$$

- M : Maximum bending moment acting on the spline shaft (N·mm)
- σ : Permissible bending stress of the spline shaft (98N/mm²)
- Z : Section modulus of the spline shaft (See Table 6) (mm³)

[Reference] Section Modulus (Solid Circle)

$$Z = \frac{\pi \cdot d^3}{32}$$

- Z : Section modulus (mm³)
- d : Shaft outer diameter (mm)

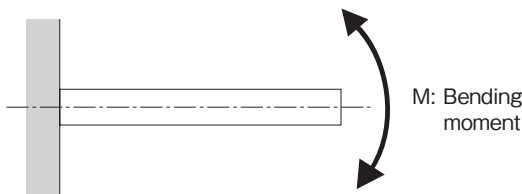

[Spline Shaft Receiving a Torsion Load]

When a torsion load is applied to the spline shaft, obtain the spline shaft diameter using the equation (2) below.

$$T = \tau_a \cdot Z_P \text{ and } Z_P = \frac{T}{\tau_a} \dots\dots\dots (2)$$

- T : Maximum torsion moment (N·mm)
- τ_a : Permissible torsion stress of the spline shaft (49N/mm²)
- Z_P : Polar section modulus of the spline shaft (See Table 6) (mm³)

[Reference] Polar Section Modulus (Solid Circle)

$$Z_P = \frac{\pi \cdot d^3}{16}$$

- Z_P : Polar section modulus (mm³)
- d : Shaft outer diameter (mm)

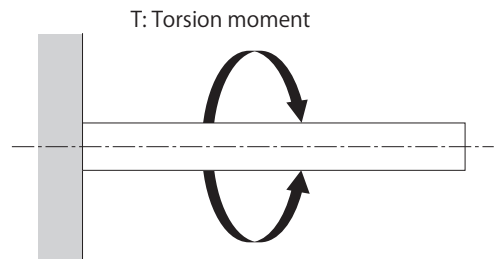

[When the Spline Shaft Simultaneously Receives a Bending Load and a Torsion Load]

When the spline shaft receives a bending load and a torsion load simultaneously, calculate two separate spline shaft diameters: one for the equivalent bending moment (M_e) and the other for the equivalent torsion moment (T_e). Then, use the greater value as the spline shaft diameter.

Corresponding Bending Moment

$$M_e = \frac{M + \sqrt{M^2 + T^2}}{2} = \frac{M}{2} \left\{ 1 + \sqrt{1 + \left(\frac{T}{M}\right)^2} \right\} \dots\dots\dots (3)$$

$$M_e = \sigma \cdot Z$$

Corresponding Torsion Moment

$$T_e = \sqrt{M^2 + T^2} = M \cdot \sqrt{1 + \left(\frac{T}{M}\right)^2} \dots\dots\dots (4)$$

$$T_e = \tau_a \cdot Z_P$$

[Distortion and Rigidity of the Spline Shaft]

The torsion rigidity of the spline shaft is expressed as a torsion angle per meter of spline shaft. Its value should be limited within 1°/4.

$$\theta = 57.3 \times \frac{T \cdot L}{G \cdot I_P} \dots\dots\dots (5)$$

$$\text{Rigidity of the shaft} = \frac{\text{Torsion angle}}{\text{Unit length}} = \frac{\theta \cdot \ell}{L} < \frac{1^\circ}{4}$$

- θ : Torsion angle (°)
- L : Spline shaft length (mm)
- G : Transverse elastic modulus (7.9×10⁴N/mm²)
- ℓ : Unit length (1000mm)
- I_P : Polar geometrical moment of inertia (See Table 6) (mm⁴)

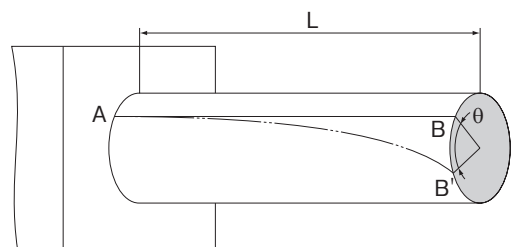

[Deflection and Deflection Angle of the Spline Shaft]

The deflection and deflection angle shaft need to be calculated using equations that meet the relevant conditions. Tables 7 represents these conditions and the corresponding equations.

Table 7 Deflection and Deflection Angle Equations

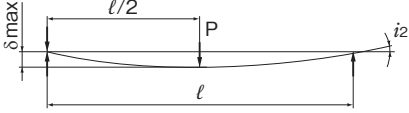
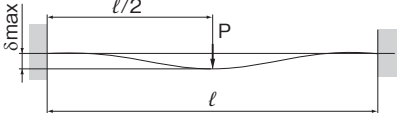
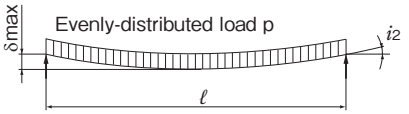
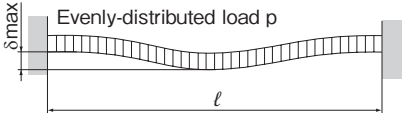
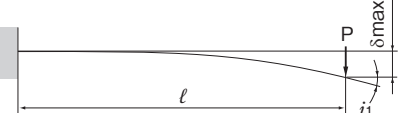
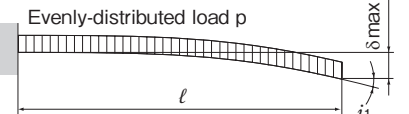
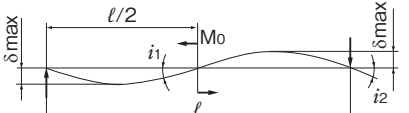
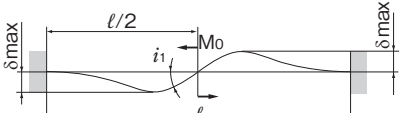
Support method	Usage conditions	Deflection equation	Deflection angle equation
Both ends free		$\delta_{\max} = \frac{Pl^3}{48EI}$	$i_1 = 0$ $i_2 = \frac{Pl^2}{16EI}$
Both ends fastened		$\delta_{\max} = \frac{Pl^3}{192EI}$	$i_1 = 0$ $i_2 = 0$
Both ends free		$\delta_{\max} = \frac{5pl^4}{384EI}$	$i_2 = \frac{pl^3}{24EI}$
Both ends fastened		$\delta_{\max} = \frac{pl^4}{384EI}$	$i_2 = 0$
One end fastened		$\delta_{\max} = \frac{Pl^3}{3EI}$	$i_1 = \frac{Pl^2}{2EI}$ $i_2 = 0$
One end fastened		$\delta_{\max} = \frac{pl^4}{8EI}$	$i_1 = \frac{pl^3}{6EI}$ $i_2 = 0$
Both ends free		$\delta_{\max} = \frac{\sqrt{3}Mol^2}{216EI}$	$i_1 = \frac{Mol}{12EI}$ $i_2 = \frac{Mol}{24EI}$
Both ends fastened		$\delta_{\max} = \frac{Mol^2}{216EI}$	$i_1 = \frac{Mol}{16EI}$ $i_2 = 0$

δ_{\max} : Maximum deflection (mm)

M_o : Moment (N·mm)

l : Span (mm)

I : Polar moment of inertia (See Table 6) (mm⁴)

i_1 : Deflection angle at loading point

i_2 : Deflection angle at supporting point

P : Concentrated load (N)

p : Uniform load (N/mm)

E : Modulus of longitudinal elasticity 2.06×10^5 (N/mm²)

[Critical Speed of the Spline Shaft]

When a Ball Spline shaft is used to transmit power while rotating, as the rotational speed of the shaft increases, the rotation cycle nears the natural frequency of the spline shaft. It may cause resonance and eventually result in inability to move. Therefore, the maximum rotational speed of the shaft must be limited to below the dangerous speed that does not cause resonance.

The dangerous speed of the spline shaft is obtained using the equation (6).
(0.8 is multiplied as a safety factor)

If the shaft's rotation cycle exceeds or nears the resonance point during operation, reconsider the spline shaft diameter.

● Critical Speed

$$N_c = \frac{60\lambda^2}{2\pi \cdot \ell_b^2} \cdot \sqrt{\frac{E \times 10^3 \cdot I}{\gamma \cdot A}} \times 0.8 \dots (6)$$

N_c : Critical speed (min⁻¹)
 ℓ_b : Distance between two mounting surfaces (mm)
 E : Young's modulus (2.06×10⁵N/mm²)
 I : Minimum moment of inertia of the shaft (mm⁴)

$$I = \frac{\pi}{64} d^4 \quad d: \text{Minor diameter} \quad (\text{mm})$$

γ : Density (specific gravity) (7.85×10⁻⁶kg/mm³)

$$A = \frac{\pi}{4} d^2 \quad d: \text{Minor diameter} \quad (\text{mm})$$

A : Spline shaft cross-sectional area (mm²)

λ : Factor according to the mounting method

- (1) Fixed - free $\lambda=1.875$
- (2) Supported - supported $\lambda=3.142$
- (3) Fixed - supported $\lambda=3.927$
- (4) Fixed - fixed $\lambda=4.73$

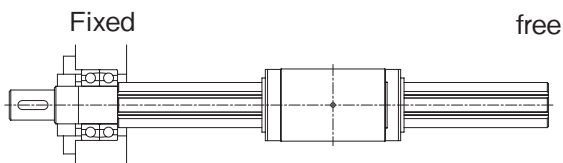

Fixed - free

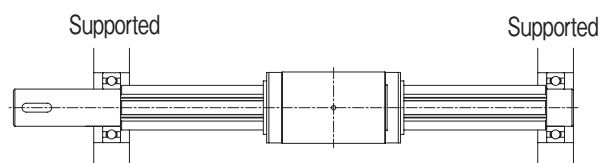

Supported - Supported

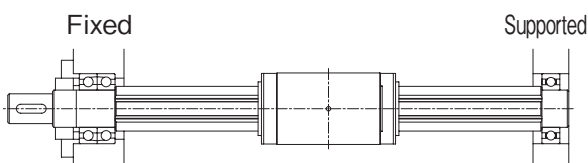

Fixed - Supported

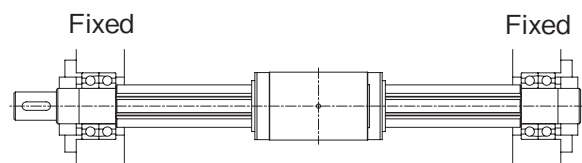

Fixed - Fixed

Predicting the Service Life

●Calculating the Static Safety Factor

To analyze a load applied to the ball spline, the average load required for calculating the service life and the maximum load needed for calculating the static safety factor must be obtained first. In particular, if the system starts and stops rapidly if impact loads occur or if a large moment or torque caused by an overhung load is applied to the system, it may receive an unexpectedly large load. When selecting a model number, make sure that the desired model is capable of receiving the required maximum load (whether stationary or in motion). The reference value of static safety factor is shown in the table below.

$$f_s = \frac{f_T \cdot f_c \cdot C_o}{P_{max}} \dots\dots\dots (7)$$

f_s : Static safety factor

C_o : Basic static load rating* (N)

P_{max} : Maximum load (N)

f_T : Temperature Factor

f_c : Contact Factor

For each factor, see the general catalog.

*The basic static load rating is a static load with a constant direction and magnitude whereby the sum of the amount of permanent deformation of the rolling element and that of the raceway on the contact area under the maximum stress is 0.0001 times the rolling element diameter.

Table 8 Reference Values of Static Safety Factor (f_s)

Machine using the Ball Spline	Load conditions	Lower limit of f_s
General industrial machinery	Without vibration or impact	3.0 to 6.0
	With vibration or impact	4.0 to 7.0
	With vibration or impact under combined loads	5.0 to 8.0

*The reference value of the static safety factor may vary according to the conditions such as the environment, lubrication condition, accuracy and rigidity of the mounting part, etc.

[Nominal Life]

The service life of a Ball Spline varies from unit to unit even if they are manufactured through the same process and used in the same operating conditions. Therefore, the nominal life defined below is normally used as a guidepost for obtaining the service life of a Ball Spline. Nominal life is the total travel distance that 90% of a group of identical ball splines independently operating under the same conditions can achieve without showing flaking (scale-like pieces on a metal surface).

[Calculating the Nominal Life]

The nominal life of a Ball Spline varies with types of loads applied during operation: torque load, radial load and moment load. The corresponding nominal life values are obtained using the equations (8) to (12) below. (The basic load ratings in these loading directions are indicated in the specification table for the corresponding model number.)

●When a Torque Load is Applied

$$L = \left(\frac{f_T \cdot f_c}{f_w} \cdot \frac{C_T}{T_c} \right)^3 \times 50 \dots\dots\dots (8)$$

●When a Radial Load is Applied

$$L = \left(\frac{f_T \cdot f_c}{f_w} \cdot \frac{C}{P_c} \right)^3 \times 50 \dots\dots\dots (9)$$

L : Nominal life (km)

C_T : Basic dynamic torque rating (N-m)

T_c : Calculated torque applied (N-m)

C : Basic dynamic load rating (N)

P_c : Calculated radial load (N)

f_T : Temperature Factor

f_c : Contact Factor

f_w : Load Factor

For each factor, see the general catalog.

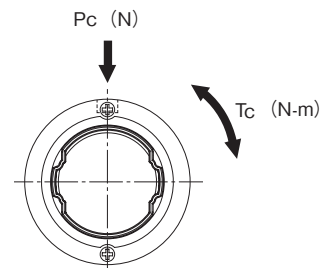

●Calculating the Service Life Time

When the nominal life (L) has been obtained in the equation above, if the stroke length and the number of reciprocations per minute are constant, the service life time is obtained using the equation (10) below.

$$L_h = \frac{L \times 10^3}{2 \times l_s \times n_1 \times 60} \dots\dots\dots (10)$$

- L_h : Service life time (h)
- l_s : Stroke length (m)
- n_1 : Number of reciprocations per minute (min^{-1})

●When a Torque Load and a Radial Load are Simultaneously Applied

When a torque load and a radial load are simultaneously applied, calculate the nominal life by obtaining the equivalent radial load using the equation (11) below.

$$P_E = P_C + \frac{4 \cdot T_c \times 10^3}{i \cdot dp \cdot \cos \alpha} \dots\dots\dots (11)$$

- P_E : Equivalent radial load (N)
- $\cos \alpha$: Contact angle i = Number of rows of balls under a load
 $\alpha = 65^\circ$ $i = 2$
- dp : Ball center-to-center diameter (mm)

●When a Moment Load is Applied to a Nut or Two Nuts in Close Contact with Each Other

Obtain the equivalent radial load using the equation (12) below.

$$P_u = K \cdot M \dots\dots\dots (12)$$

- P_u : Equivalent Radial Load with a moment applied (N)
 - K : Equivalent factor
 - M : Applied moment (N-mm)
- However, M should be within the range of the static permissible moment.

●When a Moment Load and a Radial Load are Simultaneously Applied

Calculated the nominal life from the sum of the radial load and the equivalent radial load.

■Equivalent moment factor

Table 11 Equivalent moment factor

Model No.	Equivalent factor: K		
	Single nut	Two-nut block Without Seal	Two-nut block With Seal
LT4X	0.995	0.1688	0.1350
LT/LF5X	0.980	0.1563	0.1250
LT/LF5XL	0.430	0.0925	0.0740
LT/LF6X	0.660	0.1242	0.0993
LT/LF6XL	0.360	0.0792	0.0633
LT/LF8X	0.420	0.0783	0.0626
LT/LF8XL	0.210	0.0512	0.0409
LT/LF10X	0.251	0.0517	0.0470
LT/LF13X	0.241	0.0462	0.0420
LT/LF16X	0.173	0.0352	0.0320
LT/LF20X	0.129	0.0275	0.0250
LT/LF25X	0.114	0.0242	0.0220
LT/LF30X	0.101	0.0220	0.0200

MEMO

LT-X / LT-XL

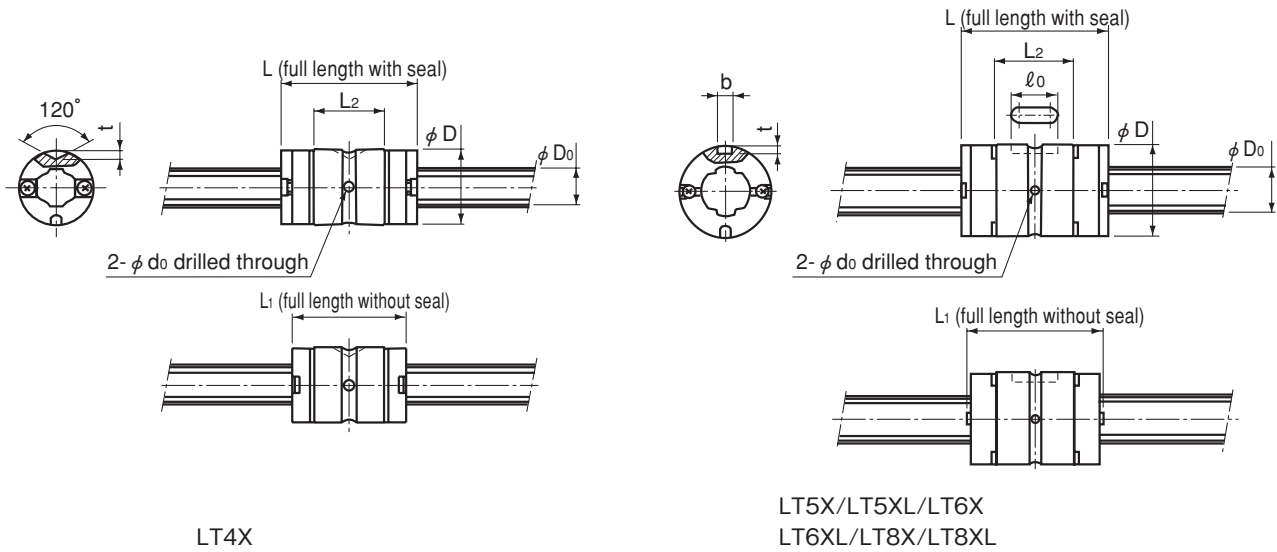

Model No.	Spline shaft diameter		Nut Dimensions							
	D ₀ h7	Outer Diameter		Length			Keyway dimensions			Greasing hole d ₀
		D	Tolerance	L (With seal)	L ₁ (Without seal)	L ₂	b H8	t	l ₀	
LT4X	4	8	0 -0.009	14.4	12	7.5	—	1	—	1
LT5X	5	10	0 -0.009	15	13.6	7.3	2	1.2	4.7	1
LT5XL				26	24.6	18.3				1
LT6X	6	12	0 -0.009	19	17.6	10.2	2	1.2	6	1
LT6XL				30	28.6	21.2				1
LT8X	8	15	0 -0.011	25	23.8	14.6	2.5	1.2	8	1
LT8XL				40	38.8	29.6				1
LT10X	10	19	0 -0.013	33	30.8	23.9	3	1.5	13	1.5
LT13X	13	23	0 -0.013	36	32.4	24	3	1.5	15	1.5
LT16X	16	28	0 -0.013	50	46.4	35.4	3.5	2	17.5	2
LT20X	20	32	0 -0.016	63	59	47.4	4	2.5	29	2
LT25X	25	40	0 -0.016	71	67	52.6	4	2.5	36	3
LT30X	30	45	0 -0.016	80	75.6	59.6	4	2.5	42	3

Model Number Coding

2 LT20X UU CL +700L P K

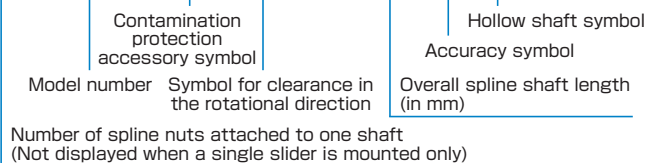

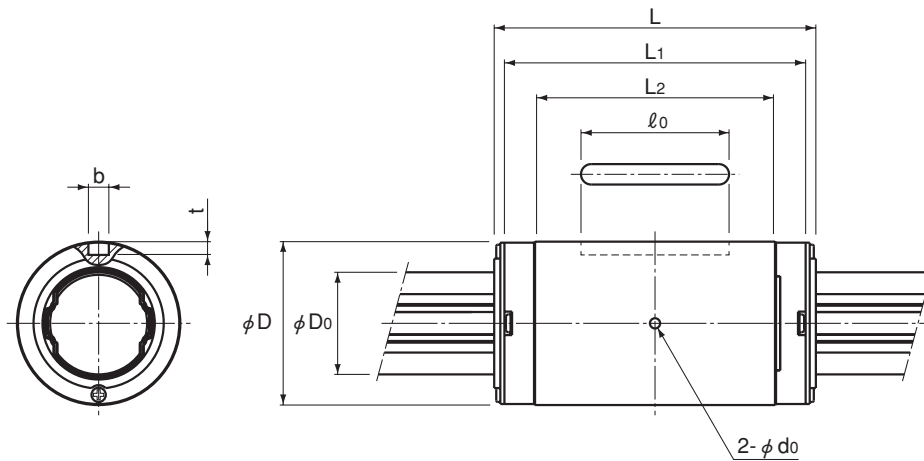

LT10X to 30X

Unit: mm

	Basic torque rating		Basic Load Rating		Static Permissible Moment			Mass
	C_T [N · m]	C_{OT} [N · m]	C [kN]	C_0 [kN]	M_{A1} [N · m]	M_{A2} (With seal) [N · m]	M_{A2} (Without seal) [N · m]	Spline Nut ^{Note)} (g)
	0.49	0.82	0.42	0.70	0.84	6.2	5.0	2.2
	0.82	1.25	0.56	0.85	1.04	8.2	6.6	3.3
	1.59	3.20	1.09	2.19	6.11	35.5	28.4	8
	1.73	2.77	0.98	1.58	2.85	19.0	15.2	6.6
	2.81	5.54	1.60	3.15	10.6	59.8	47.8	13.3
	6.00	9.23	1.39	2.15	5.13	34.3	27.4	14.3
	10.10	19.4	2.35	4.53	21.1	110.9	88.7	24.3
	9.41	17.3	2.94	5.40	21.5	114	104	30
	17.1	28.7	4.16	6.96	28.9	164	149	40
	42.9	68.6	8.40	13.4	77.4	419	381	81
	66.4	117	10.5	18.6	144	735	669	130
	125	207	15.9	26.2	230	1183	1077	235
	196	319	20.8	34.0	335	1714	1560	295

Note) The mass of the spline nut is that without seal.

Maximum manufacturing length of the spline length Unit: mm

Nominal shaft diameter	Accuracy		
	Normal grade (No symbol)	High accuracy grade (H)	Precision Grade (P)
4	200	200	200
5	250	200	200
6	315	250	200
8	500	400	315
10	1000	630	500
13	1000	800	630
16	2000	1000	1000
20	2000	1500	1000
25	3000	1500	1000
30	3000	1600	1250

LF-X / LF-XL

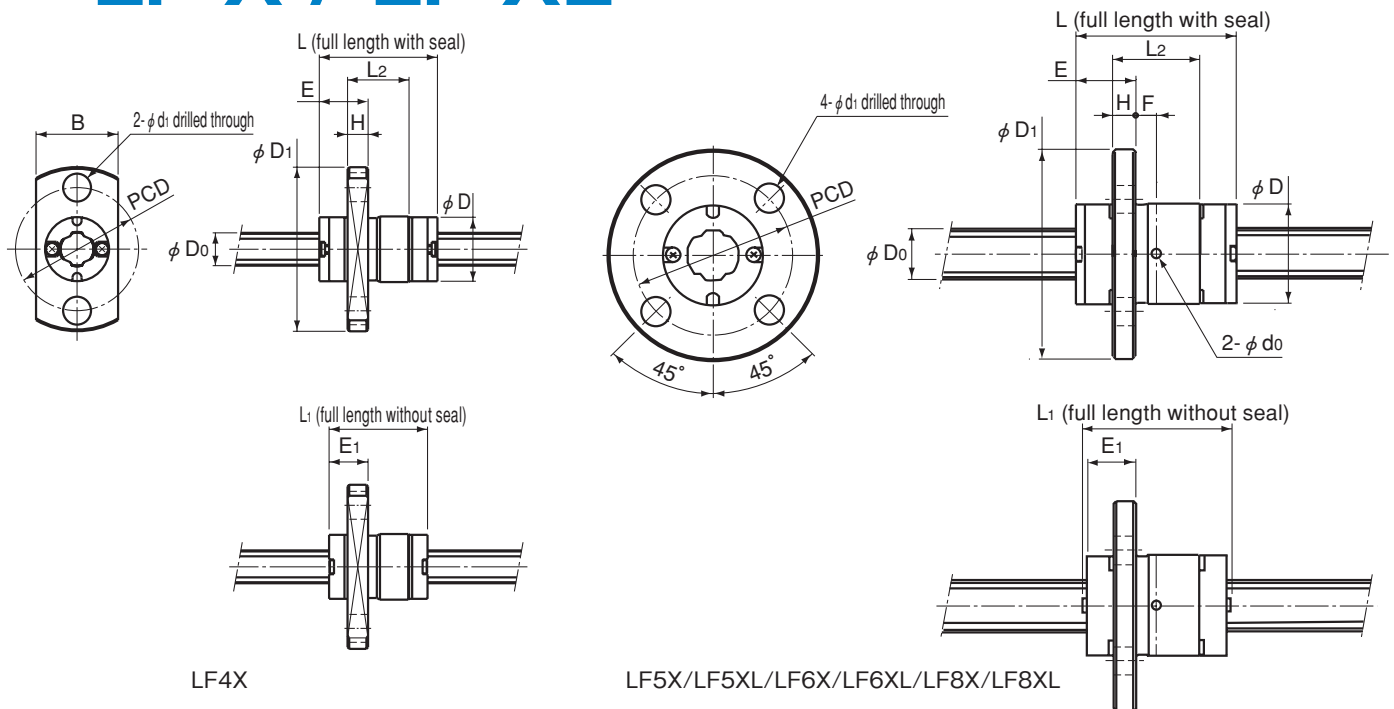

LF4X

LF5X/LF5XL/LF6X/LF6XL/LF8X/LF8XL

Model No.	Spine shaft diameter		Nut Dimensions											
	D ₀ h7	Outer Diameter		Length			Flange Outer diameter D ₁	H	F	E	E ₁	Greasing hole		Mounting hole d ₁ × d ₂ × h
		D	Tolerance	L (With seal)	L ₁ (Without seal)	L ₂						d ₀	PCD	
LF4X	4	8	0 -0.009	14.4	12	7.5	20	2.5	—	5.95	4.74	—	15	3.4 drilled through
LF5X	5	10	0	15	13.6	7.3	23	2.7	—	6.55	5.35	—	17	3.4 drilled through
LF5XL			-0.009	26	24.6	18.3			6.5					
LF6X	6	12	0	19	17.6	10.2	25	2.7	2.4	7.1	6.4	1	19	3.4 drilled through
LF6XL			-0.009	30	28.6	21.2			7.9					
LF8X	8	15	0	25	23.8	14.6	28	3.8	3.5	9	8.4	1.5	22	3.4 drilled through
LF8XL			-0.011	40	38.8	29.6			11					
LF10X	10	19	0 -0.013	33	30.8	23.9	39	6	5.95	10.55	9.45	1.5	29	4.5×8×4.4
LF13X	13	23	0 -0.013	36	32.4	24	43	6	6	12	10.2	1.5	33	4.5×8×4.4
LF16X	16	28	0 -0.013	50	46.4	35.4	48	6	11.7	13.3	11.5	2	38	4.5×8×4.4
LF20X	20	32	0 -0.016	63	59	47.4	54	8	15.7	15.8	13.8	2	43	5.5×9.5×5.4
LF25X	25	40	0 -0.016	71	67	52.6	62	8	18.3	17.2	15.2	3	51	5.5×9.5×5.4
LF30X	30	45	0 -0.016	80	75.6	59.6	74	10	19.8	20.2	18	3	60	6.6×11×6.5

Model Number Coding

2 LF20X UU CL +700L P K

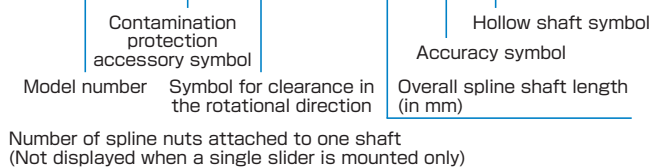

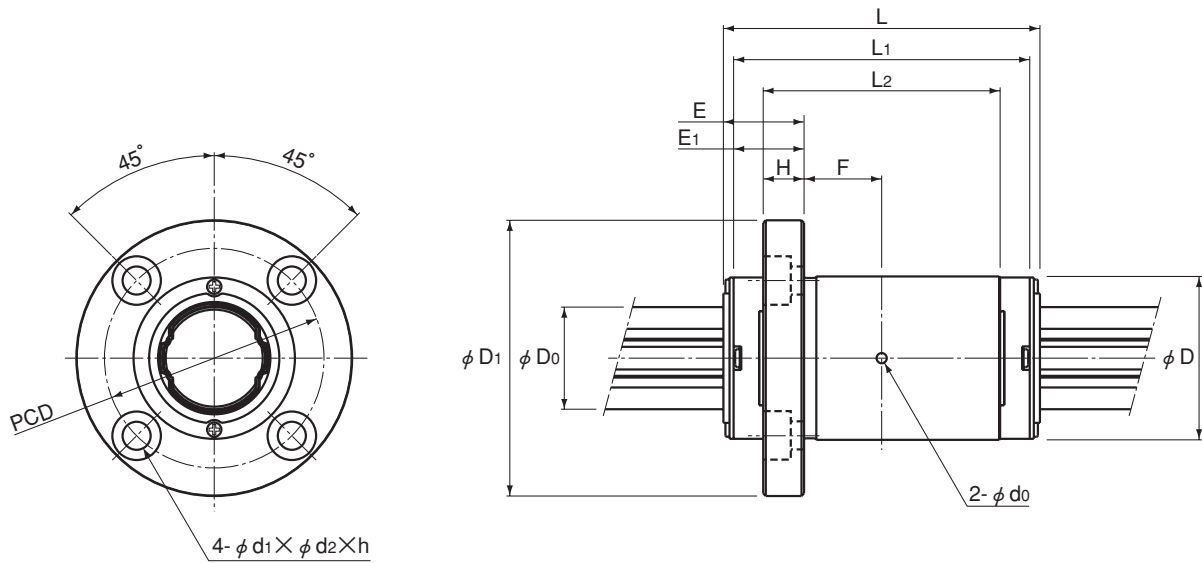

LF10X to 30X

Unit: mm

	Basic torque rating		Basic Load Rating		Static Permissible Moment			Mass
	C_T [N · m]	C_{OT} [N · m]	C [kN]	C_0 [kN]	M_{A1} [N · m]	M_{A2} (With seal) [N · m]	M_{A2} (Without seal) [N · m]	Spline Nut ^{Note)} (g)
	0.49	0.82	0.42	0.70	0.84	6.2	5.0	4.7
	0.82	1.25	0.56	0.85	1.04	8.2	6.6	9.9
	1.59	3.20	1.09	2.19	6.11	35.5	28.4	14.6
	1.73	2.77	0.98	1.58	2.85	19.0	15.2	13.8
	2.81	5.54	1.60	3.15	10.6	59.8	47.8	20.5
	6.00	9.23	1.39	2.15	5.13	34.3	27.4	26.5
	10.10	19.4	2.35	4.53	21.1	110.9	88.7	36.5
	9.41	17.3	2.94	5.40	21.5	114	104	66
	17.1	28.7	4.16	6.96	28.9	164	149	82
	42.9	68.6	8.40	13.4	77.4	419	381	131
	66.4	117	10.5	18.6	144	735	669	212
	125	207	15.9	26.2	230	1183	1077	335
	196	319	20.8	34.0	335	1714	1560	489

Note) The mass of the spline nut is that without seal.

Maximum manufacturing length of the spline length Unit: mm

Nominal shaft diameter	Accuracy		
	Normal grade (No symbol)	High accuracy grade (H)	Precision Grade (P)
4	200	200	200
5	250	200	200
6	315	250	200
8	500	400	315
10	1000	630	500
13	1000	800	630
16	2000	1000	1000
20	2000	1500	1000
25	3000	1500	1000
30	3000	1600	1250

Precautions on Use

[Handling]

- (1) Please use at least two people to move any product weighing 20 kg or more, or use a dolly or another conveyance. Otherwise, it may cause injury or damage the product.
- (2) Do not disassemble the parts. Otherwise, it may reduce the functionality.
- (3) Tilting a spline nut or spline shaft may cause them to fall by their own weight.
- (4) Take care not to drop or strike the Ball Spline. Otherwise, it may cause injury or damage the product. If the product is dropped or impacted, functionality may be reduced even if there is no surface damage.
- (5) When assembling, do not remove the spline nut from the spline shaft.
- (6) To ensure personal safety, wear gloves and protective footwear when handling this product.

[Precautions on Use]

- (1) Prevent foreign material, such as cutting chips or coolant, from entering the product. This may also cause damage to the product.
- (2) If the product is used in an environment where cutting chips, coolant, corrosive solvents, water, etc., may enter the product, use bellows, covers, etc., to prevent them from entering the product.
- (3) Do not use the product at temperature of 80°C or higher. Unless the product is specially designed to be heat-resistant, exposure to such temperatures may deform or damage plastic and rubber parts.
- (4) If foreign material such as cutting chips adheres to the product, replenish the lubricant after cleaning the product.
- (5) Micro-strokes can inhibit the formation of a film of oil between the raceways and the ball, resulting in fretting. So use grease with high fretting resistance. It is also recommended that a stroke movement corresponding to the length of the spline nut be made on a regular basis to make sure oil film is formed between the raceway and the ball.
- (6) Do not forcibly drive a pin, key, or other positioning device into this product. This may generate permanent deformation on the raceway, leading to loss of functionality.
- (7) Skewing or misalignment of the spline shaft support and spline nut can shorten service life substantially. Inspect the components carefully and make sure they are mounted correctly.
- (8) The spline nut must contain all its balls when mounted on the spline shaft. Using a spline nut with any balls removed may result in premature damage.
- (9) Please contact THK if any balls fall out of the spline nut; do not use the spline nut if any balls are missing.
- (10) When installing the spline shaft into the spline nut, identify the matching marks on the spline shaft and the spline nut, and then insert the shaft straightforward while checking their relative positions. Note that forcibly inserting the shaft may cause balls to fall off. If the spline nut is attached with a seal or given a preload, apply a lubricant to the outer surface of the spline shaft.
- (11) Manipulate the spline nut gently, using a jig, when inserting it into the housing, taking care not to strike the side plate, end cap, or seal.
- (12) Insufficient rigidity or rough mounting surface accuracy of mounting components may cause unexpected load and may result in premature damage. Accordingly, give sufficient consideration to the rigidity/accuracy of the housing and base.
- (13) If desiring to have a flanged-type Ball Spline additionally machined, such as having a dowel pin hole, contact THK.

[Lubrication]

- (1) Thoroughly wipe off anti-rust oil and feed lubricant before using the product.
- (2) Do not mix different lubricants. Mixing greases using the same type of thickening agent may still cause adverse interaction between the two greases if they use different additives, etc.
- (3) When using the product in locations exposed to constant vibrations or in special environments such as clean rooms, vacuum and low/high temperature, use the grease appropriate for the specification/environment.
- (4) To lubricate a product that has no grease nipple or oil hole, apply lubricant directly to the raceway surface and execute a few preliminary strokes to ensure that the interior is fully lubricated.
- (5) The consistency of grease changes according to the temperature. Take note that the slide resistance and torque of the Ball Spline also changes as the consistency of grease changes.
- (6) The Ball Spline may encounter increased slide resistance following lubrication, due to the lubricant's agitation resistance. Be sure to perform a break-in to let the grease spread fully, before operating the machine.
- (7) Excess lubricant may spatter immediately after lubrication. If necessary, wipe off any spattered grease.
- (8) The properties of grease deteriorate and its lubrication performance drops over time. Grease must be checked and added properly according to the use frequency of the machine.
- (9) Although the lubrication interval may vary according to use conditions and the service environment, lubrication should be performed approximately every 100 km in travel distance (three to six months). Set the final lubrication interval/amount based on the actual machine.
- (10) With oil lubrication, the lubricant may not always be thoroughly disseminated inside the Ball Spline, depending on its mounting position. If the preferred lubrication method is oil lubrication, please consult THK in advance.

[Storage]

When storing the Ball Spline, enclose it in a package designated by THK and store it in a room in a horizontal orientation while avoiding high temperature, low temperature and high humidity. After the product has been in storage for an extended period of time, lubricant inside may have deteriorated, so add new lubricant before use.

[Disposal]

Dispose of the product properly as industrial waste.

LIMITED WARRANTY

LIMITED WARRANTY AND LIMITATION OF LIABILITY: THK CO. LTD., FOR ITSELF AND ITS RELATED COMPANIES AND SUBSIDIARIES (HEREINAFTER DESCRIBED COLLECTIVELY AS "THK") WARRANTS THAT ALL THK PRODUCTS SOLD WILL BE FREE OF DEFECTS IN MATERIALS AND WORKMANSHIP FOR A PERIOD OF TWELVE (12) MONTHS FROM DATE OF DELIVERY. THE FOREGOING TWELVE (12) MONTH WARRANTY SHALL NOT BE EXTENDED OR CHANGED BY THK FURNISHING ANY REPLACEMENTS, ADDITIONS, ATTACHMENTS, ACCESSORIES OR REPAIRS TO THE PRODUCT SUBSEQUENT TO THE DATE OF DELIVERY OR ACCEPTANCE. THE FOREGOING WARRANTY IS THE SOLE AND EXCLUSIVE WARRANTY OF THK REGARDING THE PRODUCT.

DISCLAIMER OF OTHER WARRANTIES: OTHER THAN THE FOREGOING WARRANTY, THERE ARE NO EXPRESS OR IMPLIED WARRANTIES OR ANY AFFIRMATIONS OF FACT OR PROMISES BY THK WITH RESPECT TO THE PRODUCT. THK DISCLAIMS ANY WARRANTIES, EXPRESS, IMPLIED OR STATUTORY, NOT SPECIFICALLY SET FORTH ABOVE. WITHOUT LIMITING THE GENERALITY OF THE FOREGOING, THK EXPRESSLY DISCLAIMS ANY IMPLIED WARRANTIES OF MERCHANTABILITY, FITNESS FOR ANY PARTICULAR PURPOSE, INFRINGEMENT OR ANY REPRESENTATIONS OF FACT OR QUALITY NOT EXPRESSLY SET FORTH HEREIN.

LIMITATION OF LIABILITY AND REMEDIES: THK'S SOLE RESPONSIBILITY AND LIABILITY INCURRED AS A RESULT OF THE SALE AND/OR USE OF THE PRODUCT, AND THE PURCHASER'S EXCLUSIVE REMEDY AGAINST THK UNDER ANY WARRANTY SHALL BE LIMITED TO THE REPAIR OR REPLACEMENT, AT THK'S OPTION, OF PRODUCT COMPONENTS NOT CONFORMING TO THE WARRANTY. THE TOTAL LIABILITY OF THK SHALL IN NO EVENT EXCEED THE AMOUNT ACTUALLY PAID TO THK BY PURCHASER WITH RESPECT TO THE PRODUCT. THIS LIMITATION OF REMEDY IS INTENDED BY THE PARTIES TO SURVIVE EVEN IF THE REMEDY IS CLAIMED TO HAVE FAILED OF ITS ESSENTIAL PURPOSE. PURCHASER'S FULL AND COMPLETE PERFORMANCE OF ALL OBLIGATIONS OF PURCHASER RECITED IN THIS AGREEMENT IS A CONDITION PRECEDENT TO THK'S WARRANTY OBLIGATIONS AND LIABILITIES HEREIN.

PURCHASER'S DAMAGES AND LIMITATIONS: IN NO EVENT SHALL THK BE LIABLE TO PURCHASER, ITS ASSIGNS OR AGENTS, FOR ECONOMIC LOSS, INCIDENTAL OR CONSEQUENTIAL DAMAGES, IN CONTRACT OR IN TORT, INCLUDING BUT NOT LIMITED TO, ANY DAMAGES FOR LOST PROFITS, DOWN-TIME, LOST PRODUCTION, FAILURE TO MEET PURCHASER'S SALES CONTRACTS, OR DEFECTS IN PURCHASER'S MATERIALS OR WORKMANSHIP ARISING DIRECTLY OR INDIRECTLY FROM THE USE OF THE PRODUCT.

DISCLAIMER

This Catalog provides basic information relating to THK linear motion and related products. The Catalog, including all information, charts, formulas, factors, accuracy standards, tolerances and application recommendations contained herein, is only a starting point for the customer's selection of appropriate products, and may not apply in all intended applications. The Catalog is not a substitute for a proper application analysis conducted by an experienced, knowledgeable design engineer. Product selection should be based upon your specific application needs and conditions, which will vary greatly depending on many factors. No specific product application should be based solely on the information contained in this Catalog. All purchases of THK Products are subject to the limited warranty offered by THK Co., Ltd, for itself and on behalf of its related companies and subsidiaries. Customers should confirm independently that a contemplated application is safe, appropriate and effective.

"All trademarks used in this Catalog are registered trademarks in the Country of Japan. If there is any question as to the validity of such trademarks outside of Japan, an inquiry should be made in that particular country."

Technical Support Site

The THK Technical Support Site lets you access product information and technical support online. You will also find a search feature for locating desired products and a calculation feature for calculating service life. 2D-CAD and 3D-CAD data are also downloadable.

<http://www.thk.com/> or

Top page of the global site



<http://www.thk.com/>

Technical support site



<https://tech.thk.com/>

Product Information

Search by model number or description. Also contains detailed product specifications according to model number.

Technical Information

Contains technical information, from application examples to research papers.
(*To use this service, you must log in first.)

Technical Calculation

Rated life (life time) can be calculated simply by entering model number, application criteria, etc.
(*To use this service, you must log in first.)

CAD Data

You can acquire 2D-CAD data (DXF files) on approximately 4,000 items, or 3D-CAD data according to specifications from rail lengths to installation of option items.
(*To use this service, you must log in first.)

Catalog Information

Order any of a variety of catalogs. You can also view in PDF format.
(*To use this service, you must log in first.)

FAQ

Contains frequently asked questions.

Linear Motion System DVD Catalog

Linear Motion System DVD Catalog is also available. Please contact THK, distributors or other purchasable contacts in your area for a request.



Please choose your preferred language.

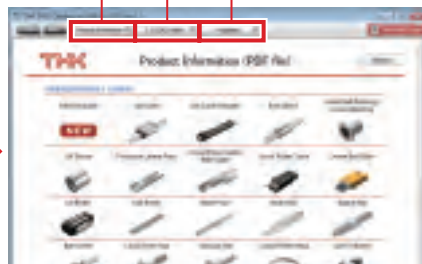

Displays product information.

Enables you to use 2-D CAD data (DXF files).

Enables you to use 3-D CAD data.

Product information (PDF file)

Contains catalog PDF data for new products and mechatronic products, in addition to the product information contained in the General Catalog.

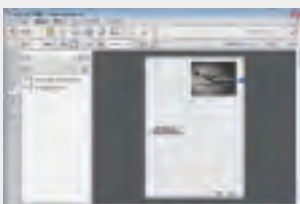

2-D CAD data (DXF file)

You can use 2-D CAD data (DXF files) for approximately 4,000 products.



3-D CAD data generation program

This function enables you to use 3-D CAD data.

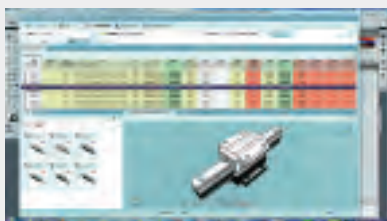

Selectable options and specifications

By combining product model numbers and options, you can generate 3-D CAD data tailored to your specifications.



3-D CAD and 2-D CAD data

You can then quickly and easily import the generated 3-D CAD data into your 3-D CAD software. 2-D CAD data can also be generated with this program.



CAD type	Formats supported
3-D CAD	DXF 3D / IGES / SAT / STEP Solidworks 2013, 2014, 2015, Macro 3D
2-D CAD	DXF Version 2004-2015

THK Compact Ball Spline

- The photo may differ slightly in appearance from the actual product.
- The appearance and specifications of the product are subject to change without notice. Contact THK before placing an order.
- Although great care has been taken in the production of this catalog, THK will not take any responsibility for damage resulting from typographical errors or omissions.
- For the export of our products or technologies and for the sale for exports, THK in principle complies with the foreign exchange law and the Foreign Exchange and Foreign Trade Control Law as well as other relevant laws.
For export of THK products as single items, contact THK in advance.

All rights reserved

THK CO., LTD.

Head Office 3-11-6 Nishigotanda, Shinagawa-ku, Tokyo 141-8503 JAPAN
International Sales Department Phone:+81-3-5434-0351 Fax:+81-3-5434-0353
Global site : <http://www.thk.com/>

NORTH AMERICA

THK America, Inc.

● HEADQUARTERS

Phone:+1-847-310-1111 Fax:+1-847-310-1271

● CHICAGO OFFICE

Phone:+1-847-310-1111 Fax:+1-847-310-1182

● NORTH EAST OFFICE

Phone:+1-631-244-1565 Fax:+1-631-244-1565

● ATLANTA OFFICE

Phone:+1-770-840-7990 Fax:+1-770-840-7897

● LOS ANGELES OFFICE

Phone:+1-949-955-3145 Fax:+1-949-955-3149

● SAN FRANCISCO OFFICE

Phone:+1-925-455-8948 Fax:+1-925-455-8965

● DETROIT OFFICE

Phone:+1-248-858-9330 Fax:+1-248-858-9455

● TORONTO OFFICE

Phone:+1-905-820-7800 Fax:+1-905-820-7811

SOUTH AMERICA

THK BRAZIL INDUSTRIA E COMERCIO LTDA.

Phone:+55-11-3767-0100 Fax:+55-11-3767-0101

EUROPE

THK GmbH

● EUROPEAN HEADQUARTERS

Phone:+49-2102-7425-555 Fax:+49-2102-7425-556

● DÜSSELDORF OFFICE

Phone:+49-2102-7425-0 Fax:+49-2102-7425-299

● STUTTGART OFFICE

Phone:+49-7141-4988-500 Fax:+49-7141-4988-888

● U.K. OFFICE

Phone:+44-1384-47-1550 Fax:+44-1384-47-1551

● ITALY OFFICE

Phone:+39-02-9901-1801 Fax:+39-02-9901-1881

● SWEDEN OFFICE

Phone:+46-8-445-7630 Fax:+46-8-445-7639

● AUSTRIA OFFICE

Phone:+43-7229-51400 Fax:+43-7229-51400-79

● SPAIN OFFICE

Phone:+34-93-652-5740 Fax:+34-93-652-5746

● TURKEY OFFICE

Phone:+90-216-362-4050 Fax:+90-216-569-7150

● PRAGUE OFFICE

Phone:+420-2-41025-100 Fax:+420-2-41025-199

● MOSCOW OFFICE

Phone:+7-495-649-80-47 Fax:+7-495-649-80-44

THK Europe B.V.

● EINDHOVEN OFFICE

Phone:+31-040-290-9500 Fax:+31-040-290-9599

THK France S.A.S.

● PARIS OFFICE

Phone:+33-1-7425-3800 Fax:+33-1-7425-3799

CHINA

THK (CHINA) CO., LTD.

● HEADQUARTERS

Phone:+86-411-8733-7111 Fax:+86-411-8733-7000

● SHANGHAI OFFICE

Phone:+86-21-6219-3000 Fax:+86-21-6219-9890

● BEIJING OFFICE

Phone:+86-10-8441-7277 Fax:+86-10-6590-3557

● CHENGDU OFFICE

Phone:+86-28-8526-8025 Fax:+86-28-8525-6357

● GUANGZHOU OFFICE

Phone:+86-20-8523-8418 Fax:+86-20-3801-0456

● SHENZHEN OFFICE

Phone:+86-755-2642-9587 Fax:+86-755-2642-9604

● XIAN OFFICE

Phone:+86-29-8834-1712 Fax:+86-29-8834-1710

THK (SHANGHAI) CO., LTD.

Phone:+86-21-6275-5280 Fax:+86-21-6219-9890

TAIWAN

THK TAIWAN CO., LTD.

● TAIPEI HEAD OFFICE

Phone:+886-2-2888-3818 Fax:+886-2-2888-3819

● TAICHUNG OFFICE

Phone:+886-4-2359-1505 Fax:+886-4-2359-1506

● TAINAN OFFICE

Phone:+886-6-289-7668 Fax:+886-6-289-7669

KOREA

SEOUL REPRESENTATIVE OFFICE

Phone:+82-2-3468-4351 Fax:+82-2-3468-4353

SINGAPORE

THK LM System Pte. Ltd.

Phone:+65-6884-5500 Fax:+65-6884-5550

THAILAND

THK RHYTHM (THAILAND) CO., LTD. LM System Division

● Bangkok Branch

Phone:+66-2751-3001 Fax:+66-2751-3003

INDIA

THK India Pvt. Ltd.

● HEADQUARTERS & Bangalore Branch

Phone:+91-80-2340-9934 Fax:+91-80-2340-9937

● Pune Branch

Phone:+91-20-4120-8742

● Chennai Branch

Phone:+91-44-4042-3132

● Ahmedabad Branch

Phone:+91-79-6134-4925

● Delhi Branch

Phone:+91-12-4676-8695